

2. Mesas Undercounters

2

MARIPOSAS: PREVISORAS DEL CAMBIO CLIMÁTICO

No solo ayudan a esparcir el polen con sus alas. Prefieren climas templados y estudios demuestran que están saliendo antes de lo normal hacia el norte. Ellas proveen una forma de estudiar los efectos del cambio climático y grandes ideas sobre cómo prevenirlo.

BUTTERFLIES: CLIMATE CHANGE FORECASTS

They don't only help spread the pollen with their wings. They prefer temperate climates and studies show that they are moving northward earlier than normal. They demonstrate a way to study the effects of climate change and can give great ideas on how to prevent it.



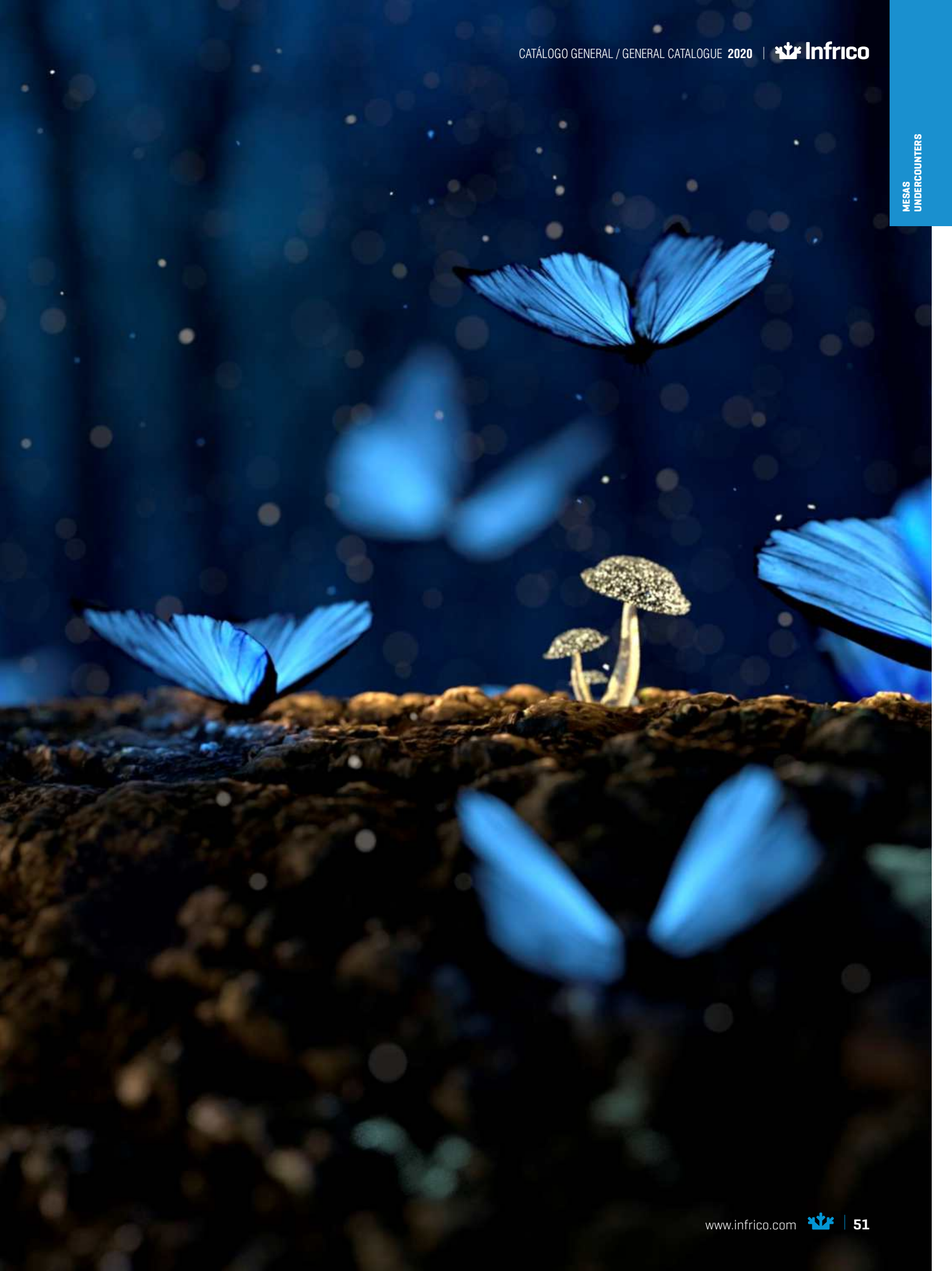



Mesa de refrigeración



Serie
600
Series

2

CARACTERÍSTICAS TÉCNICAS

Estructura



Estructura compacta totalmente **inyectada**.

Aislamiento de poliuretano de espesor 70 mm., inyectado a alta presión libre de CFC's con densidad 40 Kg/m³.

Zero ODP and **Zero GWP**.

Nuevo diseño de puertas



Nuevo diseño de **puertas con tirador de doble agarre**. Además, están dotadas con bisagras para un retorno automático y presión permanente durante el cierre. El **retorno automático** queda libre cuando la apertura supera los 95°. Incluyen **burlete plano** "cleanless" de cuatro cámaras fácilmente desmontable.

TECHNICAL CHARACTERISTICS

Structure

Compact **structure** totally **injected**.

Polyurethane insulation 70 mm thick, injected at high pressure free of CFC's with density 40 Kg / m³.

Zero ODP and **Zero GWP**.

New door design

New design of **doors with double grip handle**. **Doors equipped with hinges** for automatic return and permanent pressure during closing.

The **automatic return** is free when the opening exceeds 95°. They include **four-chamber** "cleanless" flat door gasket easily removable

BMPP 1500 II



Más detalles
y ficha técnica en:



Versión español

More details and
technical sheet:



English version

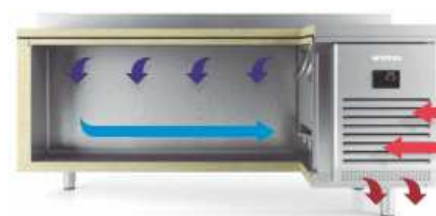

Circulación optimizada del aire
Optimal air flow

Sistema de ventilación de condensación frontal
Front breathing condensation system

Opcional: Manejo control digital por WiFi o Bluetooth®

Optional: Operating digital control by WiFi or Bluetooth®



MOD.



Acero inox
Stainless Steel
(EXT/INT)



Espesor
Thickness
(MM)



Capacidad
Capacity
(L)



Puertas
Doors



Nº parrillas J.
guías
No shelves /
Slides



Sistema de
frío
Cooling
System



Control digital
Digital control



Potencia
Power
(W)



Potencia
frigorífica
Cooling capacity
(W A -10°C)



Consumo
Consumption
(kWh/24h)



Clase
energética
Energy class



Refrigerante
Refrigerant

MOD.	Acero inox Stainless Steel (EXT/INT)	Espesor Thickness (MM)	Capacidad Capacity (L)	Puertas Doors	Nº parrillas J. guías No shelves / Slides	Sistema de frío Cooling System	Control digital Digital control	Potencia Power (W)	Potencia frigorífica Cooling capacity (W A -10°C)	Consumo Consumption (kWh/24h)	Clase energética Energy class	Refrigerante Refrigerant
BMPP 1500 II	AISI 304	70	250	2	2/2 [325x430]	Ventilado Forced air	IP65	260	343	1,55	A	R-290
BMPP 2000 II	AISI 304	70	385	3	3/3 [325x430]	Ventilado Forced air	IP65	260	343	1,80	A	R-290
BMPP 2500 II	AISI 304	70	510	4	4/4 [325x430]	Ventilado Forced air	IP65	446	690	2,05	A	R-290

Fotografías no contractuales / Non contractual pictures.

Características técnicas y constructivas sujetas a variación sin previo aviso / We reserve the right to change specifications without prior notice.

Los datos técnicos están sujetos a posibles variaciones a posibles variaciones que serán actualizadas periódicamente en las fichas técnicas del producto, disponibles en la web. The technical data are subject to possible variations that will be updated periodically in the technical data sheets of the product, which are available on the website.



Undercounter refrigerator

Serie
600
Series

MESAS
UNDERCOUNTERS

REFRIGERACIÓN



Refrigeración

Sistema de **ventilación y condensación frontal**.
Bandeja evaporativa sin resistencias eléctricas.
Nuevo sistema **Monoblock**.
Unidades sobredimensionadas y eficientes

REFRIGERATION

Refrigeration system

Front-breathing ventilation system.
Evaporative tray without electrical heater.
New **Monoblock** refrigeration system.
Oversized and efficient units

BMPP 2000 II



BMPP

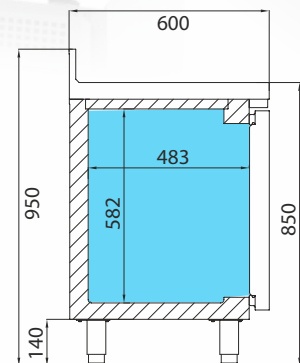

BMPP 1500 II

1468 x 600 x 850 mm.
Temp. -2°C/+8°C
C. Clima. 5 / 40° C
230V/1ph/50Hz



BMPP 2000 II

1960 x 600 x 850 mm.
Temp. -2°C/+8°C
C. Clima. 5 / 40° C
230V/1ph/50Hz



BMPP 2500 II

2452 x 600 x 850 mm.
Temp. -2°C/+8°C
C. Clima. 5 / 40° C
230V/1ph/50Hz

Opcional / Optional

Parrilla / Wire shelf [502X07]
Juego de guías / Slides [GUIAC0115430, GUIAC0215430]
Cerradura / Lock [506X209; 506X210]
Grupo lado contrario / Group opposite side [L]
Ruedas / Casters [705X16=2; 705X17=2]
Sin peto trasero / Without backsplash
115V/1ph/60Hz
230V/1ph/60Hz

Fotografías no contractuales / Non contractual pictures.

Características técnicas y constructivas sujetas a variación sin previo aviso / We reserve the right to change specifications without prior notice.

Los datos técnicos están sujetos a posibles variaciones que serán actualizadas periódicamente en las fichas técnicas del producto, disponibles en la web.

The technical data are subject to possible variations that will be updated periodically in the technical data sheets of the product, which are available on the website.





Mesa de congelación



Serie
600
Series

2

CARACTERÍSTICAS TÉCNICAS



Estructura

Estructura compacta totalmente **inyectada**.
Aislamiento de poliuretano de espesor 70 mm., inyectado a alta presión libre de CFC's con densidad 40 Kg/m³, Zero ODP and Low GWP.



Nuevo diseño de puertas

Nuevo diseño de **puertas con tirador de doble agarre**. Además, están **dotadas con bisagras** para un retorno automático y presión permanente durante el cierre. El retorno automático queda libre cuando la apertura supera los 95°. Incluyen **burlete plano** "cleanless" de cuatro cámaras fácilmente desmontables.

TECHNICAL CHARACTERISTICS

Structure

Compact **structure** totally **injected**.
Polyurethane insulation 70 mm thick, injected at high pressure free of CFC's with density 40 Kg / m³, Zero ODP and Low GWP.

New door design

New design of **doors with double grip handle**. **Doors equipped with hinges** for automatic return and permanent pressure during closing. The automatic return is free when the opening exceeds 95°. They include **four-chamber** "cleanless" flat door gasket easily removable

BMPP 1500 BT



Más detalles
y ficha técnica en:



Versión español

More details and
technical sheet:



English version



**Circulación optimizada
del aire**
Optimal air flow

**Sistema de ventilación de
condensación frontal**
Front breathing condensation system

MOD.



Acero inox
Stainless Steel
(EXT/INT)



Espesor
Thickness
(MM)



Capacidad
Capacity
(L)



Puertas
Doors



N° parrillas J.
guías
No shelves /
Slides



Sistema de
frío
Cooling
System



Control digital
Digital control



Potencia
Power
(W)



Potencia
frigorífica
Cooling capacity
(W A -30°C)



Consumo
Consumption
(kWh/24h)



Clase
energética
Energy class



Refrigerante
Refrigerant

MOD.	Acero inox Stainless Steel (EXT/INT)	Espesor Thickness (MM)	Capacidad Capacity (L)	Puertas Doors	N° parrillas J. guías No shelves / Slides	Sistema de frío Cooling System	Control digital Digital control	Potencia Power (W)	Potencia frigorífica Cooling capacity (W A -30°C)	Consumo Consumption (kWh/24h)	Clase energética Energy class	Refrigerante Refrigerant
BMPP 1500 BT	AISI 304	70	250	2	2/2 [325x430]	Ventilado Forced air	IP65	443	445	4,02	C	R-290
BMPP 2000 BT	AISI 304	70	385	3	3/3 [325x430]	Ventilado Forced air	IP65	472	445	6,57	D	R-290
BMPP 2500 BT	AISI 304	70	510	4	4/4 [325x430]	Ventilado Forced air	IP65	561	540	6,78	C	R-290

Fotografías no contractuales / Non contractual pictures.

Características técnicas y constructivas sujetas a variación sin previo aviso / We reserve the right to change specifications without prior notice.

Los datos técnicos están sujetos a posibles variaciones a posibles variaciones que serán actualizadas periódicamente en las fichas técnicas del producto, disponibles en la web. The technical data are subject to possible variations that will be updated periodically in the technical data sheets of the product, which are available on the website.



Undercounter freezer

Serie
600
Series

MESAS
UNDERCOUNTERS

REFRIGERACIÓN



Refrigeración

Sistema de **ventilación y condensación frontal**.
Sistema de **evaporación forzada**.
Bandeja de plástico con **serpentin embutido**.
Ventiladores **electrónicos**.
Desescarche por **gas caliente**.
Válvula de expansión **termostática**.

REFRIGERATION

Refrigeration system

Front-breathing ventilation system.
Forced air evaporation system.
Evaporative tray **without electrical heaters**.
Electronics fans.
Hot gas defrost.
Thermostatic **expansion valve**.

BMPP 2000 BT



BMPP

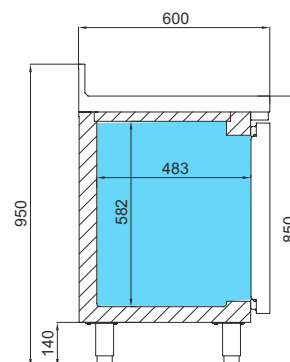

BMPP 1500 BT

1468 x 600 x 850 mm.
Temp. -18°C
C. Clima. 4 / 38°C
230V/1ph/50Hz



BMPP 2000 BT

1960 x 600 x 850 mm.
Temp. -18°C
C. Clima. 4 / 38°C
230V/1ph/50Hz



BMPP 2500 BT

2452 x 600 x 850 mm.
Temp. -18°C
C. Clima. 4 / 38°C
230V/1ph/50Hz

Opcional / Optional

Parrilla / Wire shelf [502X07]
Juego de guías / Slides [GUIAC0115430, GUIAC0215430]
Cerradura / Lock [506X209; 506X210]
Grupo lado contrario / Group opposite side [L]
Ruedas / Casters [705X16=2; 705X17=2]
Sin peto trasero / Without backsplash
115V/1ph/60Hz
230V/1ph/60Hz

Fotografías no contractuales / Non contractual pictures.

Características técnicas y constructivas sujetas a variación sin previo aviso / We reserve the right to change specifications without prior notice.

Los datos técnicos están sujetos a posibles variaciones que serán actualizadas periódicamente en las fichas técnicas del producto, disponibles en la web.

The technical data are subject to possible variations that will be updated periodically in the technical data sheets of the product, which are available on the website.





Mesa refrigerada con cajones

Serie
600
Series

2

CARACTERÍSTICAS TÉCNICAS



Estructura

Estructura compacta totalmente **inyectada**.

Aislamiento de poliuretano de espesor 70 mm., inyectado a alta presión libre de CFC's con densidad 40 Kg/m³, Zero ODP and Zero GWP.

Cajones



Cajones con guías telescópicas con salida mayorada y sistema de autocierre.

TECHNICAL CHARACTERISTICS

Structure

Compact **structure** totally **injected**.

Polyurethane insulation 70 mm thick, injected at high pressure free of CFC's with density 40 Kg / m³, Zero ODP and Zero GWP.

Drawers

Drawers with full extension slides and self closing system.

BMPP 1500



Más detalles
y ficha técnica en:



Versión español

More details and
technical sheet:



English version

MOD.	Descripción Description	Código Code	Precio Price
BMPP II,F,GR ,EN	Kit 2 cajones BM 1/2 x 200 2 drawers kit BM 1/2 x 200	[JCAJ17BM1/2]	
BMPP II, F, GR ,EN	Kit 3 cajones BM 1/3 x 100 3 drawers kit BM 1/3 x 100	[JCAJ17BM1/3]	
BMPP II, F, GR ,EN	Kit 3 cajones BM 2/3 + BM 1/3 3 drawers kit BM 2/3 + BM 1/3	[JCAJ17BM2/3]	

Fotografías no contractuales / Non contractual pictures.

Características técnicas y constructivas sujetas a variación sin previo aviso / We reserve the right to change specifications without prior notice.

Los datos técnicos están sujetos a posibles variaciones que serán actualizadas periódicamente en las fichas técnicas del producto, disponibles en la web.
The technical data are subject to possible variations that will be updated periodically in the technical data sheets of the product, which are available on the website.



Drawers undercounter refrigerator

Serie
600
Series

MESAS
UNDERCOUNTERS

REFRIGERACIÓN

Refrigeración

Sistema de **ventilación y condensación frontal**.
Bandeja evaporativa sin resistencias eléctricas.
Nuevo sistema **Monoblock**.



REFRIGERATION

Refrigeration system

Front-**breathing ventilation system**.
Evaporative tray without electrical heaters.
New **Monoblock** system.

BMPP 2000



Kit 2 cajones
2 drawers kit

Kit 2 cajones
2 drawers kit

Kit 3 cajones
3 drawers kit

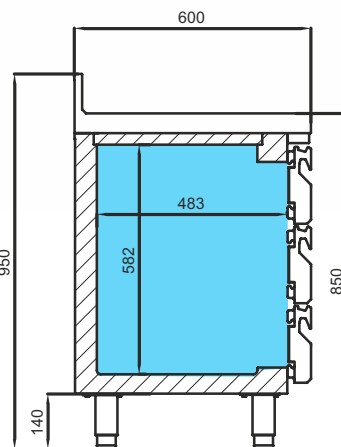
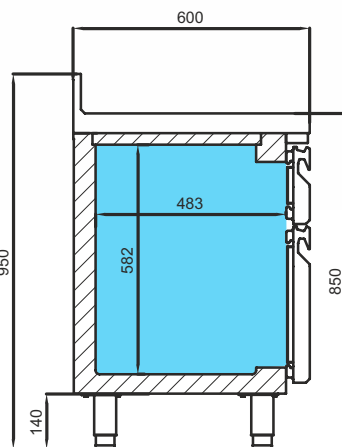
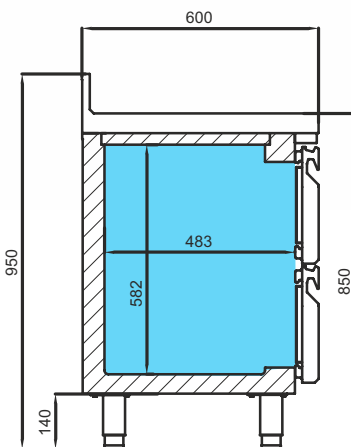

Cajón 1/3 / drawer
302 x 418 x 105

Cajón 1/2 / drawer
302 x 418 x 205

Cajón 2/3 / drawer
302 x 418 x 307

BM 1/2 x 200

BM 2/3x300 + BM 1/3x100

BM 1/3x100

Fotografías no contractuales / Non contractual pictures.

Características técnicas y constructivas sujetas a variación sin previo aviso / We reserve the right to change specifications without prior notice.

Los datos técnicos están sujetos a posibles variaciones que serán actualizadas periódicamente en las fichas técnicas del producto, disponibles en la web.

The technical data are subject to possible variations that will be updated periodically in the technical data sheets of the product, which are available on the website.





Mesa refrigerada con puertas cristal Glass door undercounter refrigerator



Serie
600
Series

2

BMPP 1500 CR



Más detalles
y ficha técnica en:



Versión español

More details and
technical sheet:



English version

Nuevo diseño de puerta de cristal
New glass door design

Doble cristal templado bajo emisivo más carga Argón 4-27-4
Double tempered glass low-e + Argón 4-27-4

Opcional / Optional

- Parrilla / Wire shelf [502X43]
- Juego de guías / Slides [GUIAC0115430, GUIAC0215430]
- Cerradura / Lock [506X60]
- Grupo lado contrario / Group opposite side [L]
- Iluminación LED RGB con cambio de color [por puerta]
- LED Lighting RGB change of colour [per door]
- 115V/1ph/60Hz
- 230V/1ph/60Hz

BMPP CR

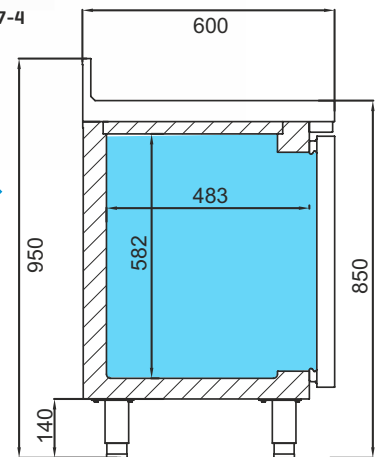

BMPP 1500 CR

1468 x 600 x 850 mm.
Temp. +2°C/+6°C
C. Clima. 4 / 38°C
230V/1ph/50Hz



BMPP 2000 CR

1960 x 600 x 850 mm.
Temp. +2°C/+6°C
C. Clima. 4 / 38°C
230V/1ph/50Hz



BMPP 2500 CR

2452 x 600 x 850 mm.
Temp. +2°C/+6°C
C. Clima. 4 / 38°C
230V/1ph/50Hz

MOD.



Acero inox
Stainless Steel
(EXT/INT)



Espesor
Thickness
(MM)



Capacidad
Capacity
(L)



Puertas
Doors



N° parrillas J. guías
No shelves /
Slides



Sistema de frío
Cooling System



Control digital
Digital control



Led



Potencia
Power
(W)



Potencia frigorífica
Cooling capacity
(W A -10°C)



Refrigerante
Refrigerant

Model	Acero inox Stainless Steel (EXT/INT)	Espesor Thickness (MM)	Capacidad Capacity (L)	Puertas Doors	N° parrillas J. guías No shelves / Slides	Sistema de frío Cooling System	Control digital Digital control	Led	Potencia Power (W)	Potencia frigorífica Cooling capacity (W A -10°C)	Refrigerante Refrigerant
BMPP 1500 CR	AISI 304	70	250	2	2/2 [325x430]	Ventilado Forced air	IP65	✓	270	343	R-290
BMPP 2000 CR	AISI 304	70	385	3	3/3 [325x430]	Ventilado Forced air	IP65	✓	460	690	R-290
BMPP 2500 CR	AISI 304	70	510	4	4/4 [325x430]	Ventilado Forced air	IP65	✓	465	690	R-290

Fotografías no contractuales / Non contractual pictures.

Características técnicas y constructivas sujetas a variación sin previo aviso / We reserve the right to change specifications without prior notice.

Los datos técnicos están sujetos a posibles variaciones que serán actualizadas periódicamente en las fichas técnicas del producto, disponibles en la web.
The technical data are subject to possible variations that will be updated periodically in the technical data sheets of the product, which are available on the website.





Mesa refrigerada con fregadero

Sink undercounter refrigerator



Serie
600
Series

MESAS
UNDERCOUNTERS

BMPPF 2000 II

Opcional
Optional



Más detalles
y ficha técnica en:



Versión español

More details and
technical sheet:



English version

Opcional / Optional

Parrilla / Wire shelf [502X07]
Juego de guías / Slides [GUIACO115430, GUIACO215430]
Cerradura / Lock [506X209; 506X210]
Grupo lado contrario / Group opposite side [L]
115V/1ph/60Hz
230V/1ph/60Hz

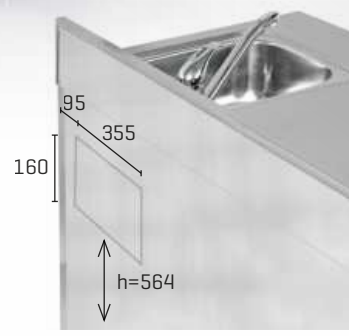

F= Fregadero / Sink



BMPPF 1500 II

1468 x 600 x 850 mm.
Temp. -2°C/+8°C
C. Clima. 5 / 40°C
230V/1ph/50Hz



BMPPF 2000 II

1960 x 600 x 850 mm.
Temp. -2°C/+8°C
C. Clima. 5 / 40°C
230V/1ph/50Hz



BMPPF 2500 II

2452 x 600 x 850 mm.
Temp. -2°C/+8°C
C. Clima. 5 / 40°C
230V/1ph/50Hz

MOD.

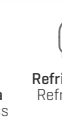

	Acero inox Stainless Steel (EXT/INT)	Espesor Thickness (MM)	Capacidad Capacity (L)	Puertas Doors	Nº parrillas J. guías No shelves / Slides	Sistema de frío Cooling System	Control digital Digital control	Potencia Power (W)	Potencia frigorífica Cooling capacity (W A -10°C)	Consumo Consumption (kWh/24h)	Clase energética Energy class	Refrigerante Refrigerant
BMPPF 1500 II	AISI 304	70	250	2	2/2 [325x430]	Ventilado Forced air	IP65	260	343	1,55	A	R-290
BMPPF 2000 II	AISI 304	70	385	3	3/3 [325x430]	Ventilado Forced air	IP65	260	343	1,80	A	R-290
BMPPF 2500 II	AISI 304	70	510	4	4/4 [325x430]	Ventilado Forced air	IP65	446	690	2,05	A	R-290

Fotografías no contractuales / Non contractual pictures.

Características técnicas y constructivas sujetas a variación sin previo aviso / We reserve the right to change specifications without prior notice.

Los datos técnicos están sujetos a posibles variaciones que serán actualizadas periódicamente en las fichas técnicas del producto, disponibles en la web.

The technical data are subject to possible variations that will be updated periodically in the technical data sheets of the product, which are available on the website.





Mesa refrigerada pre-instalada

Serie
600
Series

2

CARACTERÍSTICAS TÉCNICAS

Estructura

Estructura compacta totalmente **inyectada**.

Aislamiento de poliuretano de espesor 70 mm., inyectado a alta presión libre de CFC's con densidad 40 Kg/m³, Zero ODP and Low GWP.

Nuevo diseño de puertas

Nuevo diseño de **puertas con tirador de doble agarre**. Además, están dotadas con bisagras para un retorno automático y presión permanente durante el cierre. El retorno automático queda libre cuando la apertura supera los 95°. Incluyen burlete plano "cleanless" de cuatro cámaras fácilmente desmontables.

TECHNICAL CHARACTERISTICS

Structure

Compact **structure** totally **injected**.

Polyurethane insulation 70 mm thick, injected at high pressure free of CFC's with density 40 Kg / m³, Zero ODP and Low GWP.

New door design

New design of **doors with double grip handle**. **Doors equipped with hinges** for automatic return and permanent pressure during closing. The automatic return is free when the opening exceeds 95°. They include four-chamber "cleanless" flat door gasket easily removable.

BMPP 1500 GR



Posibilidad de acceso frontal y lateral para una mejor manipulación.

Front and lateral access for better handling

22cm

Más detalles y ficha técnica en:

More details and technical sheet:



Versión español



English version

MOD.



Acero inox
Stainless Steel
[EXT/INT]



Espesor
Thickness
[MM]



Capacidad
Capacity
[L]



Puertas
Doors



Nº parrillas J. guías
No shelves /
Slides



Sistema de frío
Cooling System



Control digital
Digital control



Potencia
frigorífica
Cooling capacity
[W A -10°C/ -30°C]
Recomendado Recommended

MOD.	Acero inox Stainless Steel [EXT/INT]	Espesor Thickness [MM]	Capacidad Capacity [L]	Puertas Doors	Nº parrillas J. guías No shelves / Slides	Sistema de frío Cooling System	Control digital Digital control	Potencia frigorífica Cooling capacity [W A -10°C/ -30°C] Recomendado Recommended
BMPP 1500 GR	AISI 304	70	250	2	2/2 [325x430]	Ventilado Forced air	IP65	343
BMPP 1500 GRBT	AISI 304	70	250	2	2/2 [325x430]	Ventilado Forced air	IP65	445
BMPP 2000 GR	AISI 304	70	385	3	3/3 [325x430]	Ventilado Forced air	IP65	343
BMPP 2000 GRBT	AISI 304	70	385	3	3/3 [325x430]	Ventilado Forced air	IP65	445

Fotografías no contractuales / Non contractual pictures.

Características técnicas y constructivas sujetas a variación sin previo aviso / We reserve the right to change specifications without prior notice.

Los datos técnicos están sujetos a posibles variaciones que serán actualizadas periódicamente en las fichas técnicas del producto, disponibles en la web. The technical data are subject to possible variations that will be updated periodically in the technical data sheets of the product, which are available on the website.



Remote undercounter refrigerator

Serie
600
Series

MESAS
UNDERCOUNTERS

REFRIGERACIÓN



Refrigeración

Tubo conexión del evaporador de 3/8" [No se incluye capilar].
Sistema de **evaporación forzada**.
Desescarche por **gas caliente [GRBT]**.

REFRIGERATION

Refrigeration system

Supplied with 3/8" connection pipes for the evaporator.
Forced-air evaporator.
Hot gas defrost [GRBT].

BMPP 2000 GR



Posibilidad de acceso frontal y lateral para una mejor manipulación.
Front and lateral access for better handling

22cm



BMPP 1500 GR

1240 x 600 x 850 mm.
Temp. 0°C/+6°C
230V/1ph/50Hz



BMPP 1500 GRBT

1240 x 600 x 850 mm.
Temp. -18°C
230V/1ph/50Hz

BMPP 1500 GR

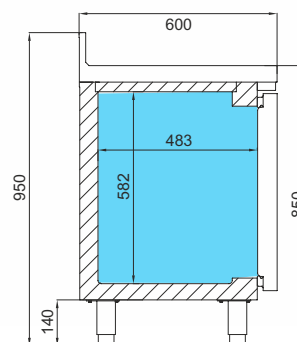

BMPP 2000 GR

1732 x 600 x 850 mm.
Temp. 0°C/+6°C
230V/1ph/50Hz



BMPP 2000 GRBT

1732 x 600 x 850 mm.
Temp. -18°C
230V/1ph/50Hz

Opcional / Optional

Válvula de expansión (especificar refrigerante)
/Expansion valve (specify refrigerant)
Parrilla / Wire shelf [502X07]
Juego de guías / Slides [GUIAC0115430, GUIAC0215430]
Puerta de cristal (unidad)
Glass door (unit) [PUE17IDGN-PUE17IIGN][GR]
Cerradura / Lock [506X209; 506X210]
115V/1ph/60Hz
230V/1ph/60Hz





Mesa refrigerada para ensaladas



Serie
600
Series

2

CARACTERÍSTICAS TÉCNICAS

Encimera EN

Refrigeración estática superior.

Importante: Las bandejas deben contener producto previamente refrigerado.



Nuevo diseño de puertas

Nuevo diseño de **puertas con tirador de doble agarre**. Además, están dotadas con bisagras para un retorno automático y presión permanente durante el cierre. El retorno automático queda libre cuando la apertura supera los 95°. Incluyen burllete plano "cleanless" de cuatro cámaras fácilmente desmontables.

TECHNICAL CHARACTERISTICS

Worktop EN (Salads)

Upper **static refrigeration**.

Important: The trays should contain previously refrigerated product.

New door design

New design of **doors with double grip handle**. Doors equipped with **hinges** for automatic return and permanent pressure during closing. The automatic return is free when the opening exceeds 95°. They include four-chamber "cleanless" flat door gasket easily removable.

BMPP 1500 EN



Refrigeración estática en la cuba
Static cooling in the tank

Más detalles y ficha técnica en:



Versión español

More details and technical sheet:



English version

Opcional / Optional

BMPP 1500 EN

[501X16] = 8



MOD.



Acero inox
Stainless Steel
[EXT/INT]



Espesor
Thickness
[MM]



Capacidad
Capacity
[L]



Puertas
Doors



Nº parrillas J. guías
No shelves /
Slides



Sistema de frío
Cooling System



Control digital
Digital control



Potencia
Power
[W]



Potencia frigorífica
Cooling capacity
[W A -10°C]



Refrigerante
Refrigerant

MOD.	Acero inox Stainless Steel [EXT/INT]	Espesor Thickness [MM]	Capacidad Capacity [L]	Puertas Doors	Nº parrillas J. guías No shelves / Slides	Sistema de frío Cooling System	Control digital Digital control	Potencia Power [W]	Potencia frigorífica Cooling capacity [W A -10°C]	Refrigerante Refrigerant
BMPP 1500 EN	AISI 304	70	250	2	2/2 [325x430]	Ventilado Forced air	IP65	249	343	R-290
BMPP 2000 EN	AISI 304	70	385	3	3/3 [325x430]	Ventilado Forced air	IP65	249	343	R-290

Fotografías no contractuales / Non contractual pictures.

Características técnicas y constructivas sujetas a variación sin previo aviso / We reserve the right to change specifications without prior notice.

Los datos técnicos están sujetos a posibles variaciones que serán actualizadas periódicamente en las fichas técnicas del producto, disponibles en la web. The technical data are subject to possible variations that will be updated periodically in the technical data sheets of the product, which are available on the website.



Salad prep refrigerator undercounter

Serie
600
Series

MESAS
UNDERCOUNTERS

REFRIGERACIÓN



Refrigeración

Sistema de **ventilación y condensación frontal**.
Bandeja evaporativa sin resistencias eléctricas.
Nuevo sistema **Monoblock**.

REFRIGERATION

Refrigeration

Front-**breathing ventilation system**.
Evaporative tray without electrical heaters.
New **Monoblock** refrigeration system.

BMPP 2000 EN



Opcional / Optional

BMPP 2000 EN

[501X16] = 11



BMPP EN

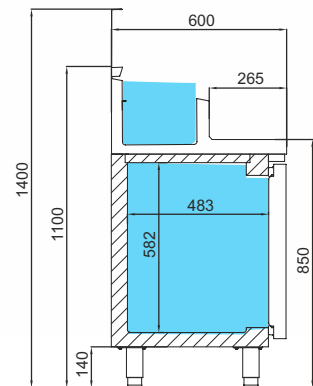

BMPP 1500 EN

1468 x 600 x 1100 mm.
Temp. 0°/+6°C.
C. Clima. 4 / 38°C
230V/1ph/50Hz



BMPP 2000 EN

1960 x 600 x 1100 mm.
Temp. 0°/+6°C.
C. Clima. 4 / 38°C
230V/1ph/50Hz

Opcional / Optional

Parrilla / Wire shelf [502X07]
Juego de guías / Slides [GUIAC0115430, GUIAC0215430]
Cerradura / Lock [506X209; 506X210]
Ruedas / Casters [705X16=2; 705X17=2]
115V/1ph/60Hz
230V/1ph/60Hz

Fotografías no contractuales / Non contractual pictures.

Características técnicas y constructivas sujetas a variación sin previo aviso / We reserve the right to change specifications without prior notice.

Los datos técnicos están sujetos a posibles variaciones que serán actualizadas periódicamente en las fichas técnicas del producto, disponibles en la web.

The technical data are subject to possible variations that will be updated periodically in the technical data sheets of the product, which are available on the website.

