

2. Mesas Undercounters

2

MARIPOSAS: PREVISORAS DEL CAMBIO CLIMÁTICO

No solo ayudan a esparcir el polen con sus alas. Prefieren climas templados y estudios demuestran que están saliendo antes de lo normal hacia el norte. Ellas proveen una forma de estudiar los efectos del cambio climático y grandes ideas sobre cómo prevenirlo.

BUTTERFLIES: CLIMATE CHANGE FORECASTS

They don't only help spread the pollen with their wings. They prefer temperate climates and studies show that they are moving northward earlier than normal. They demonstrate a way to study the effects of climate change and can give great ideas on how to prevent it.



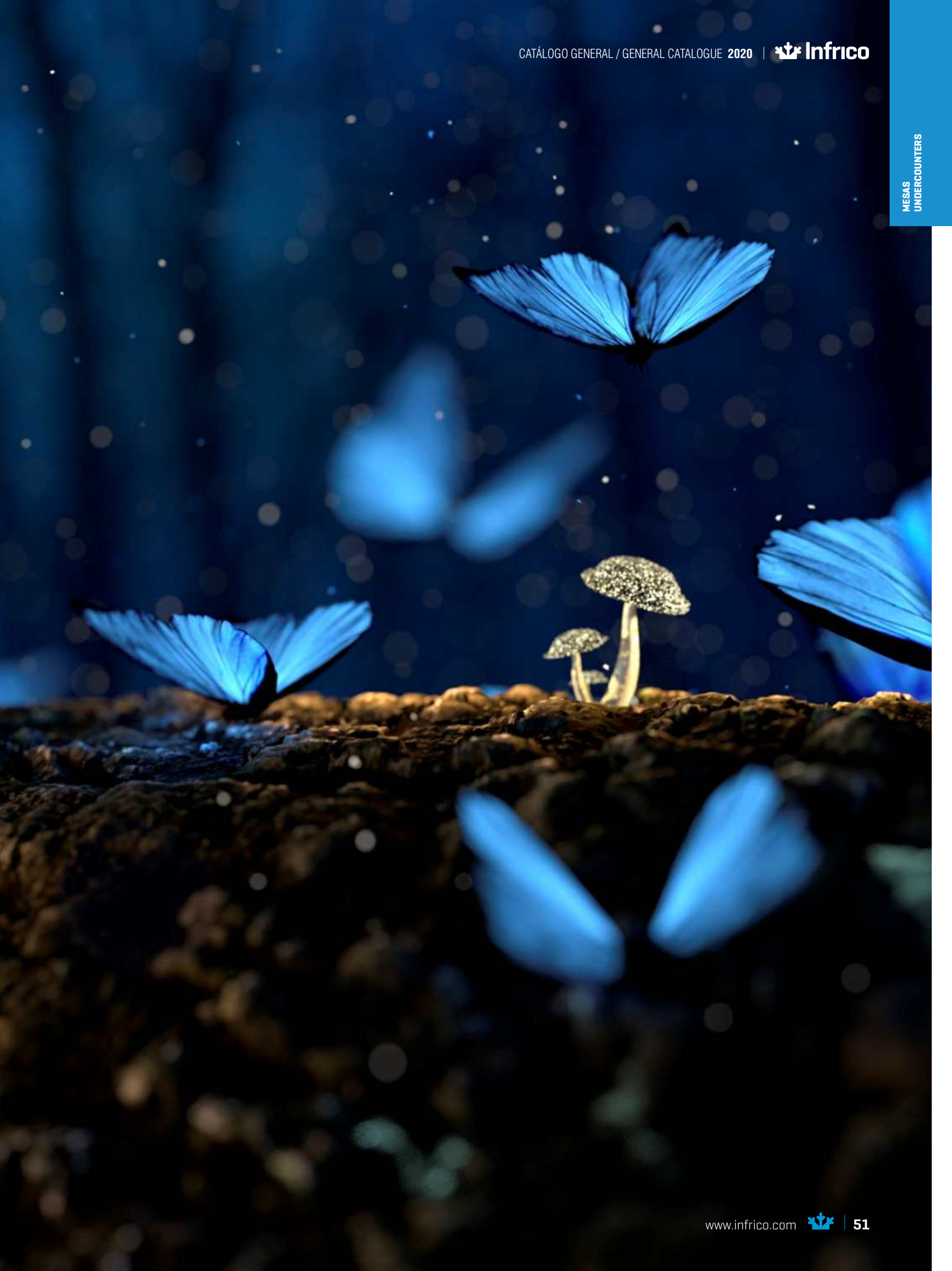



Mesa baja refrigeración



Serie
GN1/1700
Series

2

CARACTERÍSTICAS TÉCNICAS

Estructura

Estructura compacta totalmente **inyectada**.

Aislamiento de poliuretano de espesor 70 mm., **inyectado a alta presión** libre de CFC's con densidad 40 Kg/m³, Zero ODP and Zero GWP.



Cajones

Cajones con guías telescópicas con salida mayorada y sistema de autocierre.



TECHNICAL CHARACTERISTICS

Estructure

Compact **structure** totally **injected**.

Polyurethane insulation 70 mm thick, **injected at high pressure** free of CFC's with density 40 Kg / m³, Zero ODP and Zero GWP.

Drawers

Drawers with full extension slides and self closing system.

MSG 1400



Puerta opcional
Optional door

Más detalles
y ficha técnica en:



Versión español

More details and
technical sheet:



English version

Opcional: Manejo
control digital por
WiFi o Bluetooth®

Optional: Operating
digital control by
WiFi or Bluetooth®



MOD.



Acero inox
Stainless Steel
(EXT/INT)



Espesor
Thickness
(MM)



Capacidad
Capacity
(L)



Nº cajones
Nº Drawers



Sistema de frío
Cooling System



Control digital
Digital control



Potencia
Power
(W)



Potencia
frigorífica
Cooling capacity
(W A -10°C)



Consumo
Consumption
(kWh/24h)



Clase
energética
Energy class



Refrigerante
Refrigerant

MOD.	Acero inox Stainless Steel (EXT/INT)	Espesor Thickness (MM)	Capacidad Capacity (L)	Nº cajones Nº Drawers	Sistema de frío Cooling System	Control digital Digital control	Potencia Power (W)	Potencia frigorífica Cooling capacity (W A -10°C)	Consumo Consumption (kWh/24h)	Clase energética Energy class	Refrigerante Refrigerant
MSG 1000	AISI 304	70	100	2	Ventilado Forced air	IP65	223	343	0,98	A	R-290
MSG 1400	AISI 304	70	190	4	Ventilado Forced air	IP65	263	343	1,23	A	R-290
MSG 1600	AISI 304	70	225	4	Ventilado Forced air	IP65	263	343	1,33	A	R-290
MSG 2000	AISI 304	70	310	6	Ventilado Forced air	IP65	263	343	1,61	B	R-290
MSG 2400	AISI 304	70	435	8	Ventilado Forced air	IP65	436	690	1,77	B	R-290

Fotografías no contractuales / Non contractual pictures.

Características técnicas y constructivas sujetas a variación sin previo aviso / We reserve the right to change specifications without prior notice.

Los datos técnicos están sujetos a posibles variaciones a posibles variaciones que serán actualizadas periódicamente en las fichas técnicas del producto, disponibles en la web.
The technical data are subject to possible variations that will be updated periodically in the technical data sheets of the product, which are available on the website.



Counter bases refrigerator

Serie
GN1/1 700
Series

MESAS
UNDERCOUNTERS

REFRIGERACIÓN



Refrigeración

Sistema de **ventilación y condensación frontal**.
Bandeja evaporativa sin resistencias eléctricas.
Nuevo sistema **Monoblock**.
Unidades sobredimensionadas y eficientes

REFRIGERATION

Refrigeration

Front-breathing ventilation system.
Evaporative tray without electrical heaters.
New **Monoblock** refrigeration system.
Oversized and efficient units

MSG 2000



MSG 1000

1000 x 700 x 650 mm.
Temp. -2°C/+8°C
C. Clima. 5 / 40°C
230V/1ph/50Hz



MSG 1400

1400 x 700 x 650 mm.
Temp. -2°C/+8°C
C. Clima. 5 / 40°C
230V/1ph/50Hz



MSG 1600

1600 x 700 x 650 mm.
Temp. -2°C/+8°C
C. Clima. 5 / 40°C
230V/1ph/50Hz



MSG 2000

2000 x 700 x 650 mm.
Temp. -2°C/+8°C
C. Clima. 5 / 40°C
230V/1ph/50Hz



MSG 2400

2400 x 700 x 650 mm.
Temp. -2°C/+8°C
C. Clima. 5 / 40°C
230V/1ph/50Hz

MSG

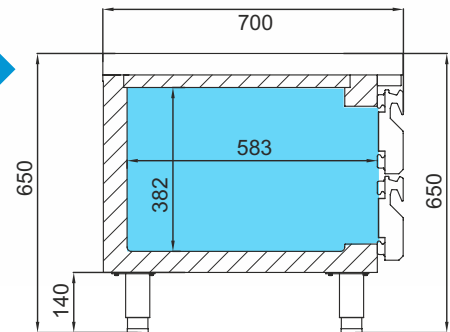

Opcional / Optional

Cerradura / Lock [506X209; 506X210]
Puerta [unidad] / Door [unit] [PUE17ISN]
Cajón 2/3x300 / Drawer 2/3x300 [JCAJ17SN2/3]
Sin incremento / Without supplement





Mesa de refrigeración



Serie
GN1/1700
Series

2

CARACTERÍSTICAS TÉCNICAS



Estructura

Estructura compacta totalmente inyectada.

Aislamiento de poliuretano de espesor 70 mm., **inyectado a alta presión** libre de CFC's con densidad 40 Kg/m³, Zero ODP and Zero GWP.



Nuevo diseño de puertas

Nuevo diseño de **puertas con tirador de doble agarre**. Además, están dotadas con bisagras para un retorno automático y presión permanente durante el cierre. El retorno automático queda libre cuando la apertura supera los 95°. Incluyen burlate plano "cleanless" de cuatro cámaras fácilmente desmontables.

TECHNICAL CHARACTERISTICS

Structure

Compact **structure totally injected.**

Polyurethane insulation 70 mm thick, **injected at high pressure** free of CFC's with density 40 Kg / m³, Zero ODP and Zero GWP.

New door design

New design of **doors with double grip handle**. **Doors equipped with hinges** for automatic return and permanent pressure during closing. The automatic return is free when the opening exceeds 95°. They include four-chamber "cleanless" flat door gasket easily removable.

BMGN 1470 II



Opcional: Manejo control digital por WiFi o Bluetooth

Optional: Operating digital control by WiFi or Bluetooth

Más detalles y ficha técnica en:



Versión español

More details and technical sheet:

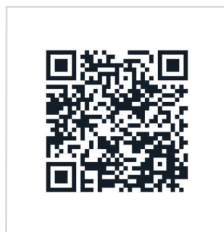

English version



Circulación optimizada del aire
Optimal air flow

Sistema de ventilación de condensación frontal
Front breathing condensation system

MOD.



Acero inox
Stainless Steel
(EXT/INT)



Espesor
Thickness
(MM)



Capacidad
Capacity
(L)



Puertas
Doors



Nº parrillas J.
guías
No shelves /
Slides



Sistema de
frío
Cooling
System



Control digital
Digital control



Potencia
Power
(W)



Potencia
frigorífica
Cooling capacity
(W A -10°C)



Consumo
Consumption
(kWh/24h)



Clase
energética
Energy class



Refrigerante
Refrigerant

MOD.	Acero inox Stainless Steel (EXT/INT)	Espesor Thickness (MM)	Capacidad Capacity (L)	Puertas Doors	Nº parrillas J. guías No shelves / Slides	Sistema de frío Cooling System	Control digital Digital control	Potencia Power (W)	Potencia frigorífica Cooling capacity (W A -10°C)	Consumo Consumption (kWh/24h)	Clase energética Energy class	Refrigerante Refrigerant
BMGN 1470 II	AISI 304	70	305	2	2/10 [325x530]	Ventilado Forced air	IP65	263	343	1,50	A	R-290
BMGN 1960 II	AISI 304	70	465	3	3/15 [325x530]	Ventilado Forced air	IP65	448	690	1,95	A	R-290
BMGN 2450 II	AISI 304	70	630	4	4/20 [325x530]	Ventilado Forced air	IP65	448	690	2,25	A	R-290

Fotografías no contractuales / Non contractual pictures.

Características técnicas y constructivas sujetas a variación sin previo aviso / We reserve the right to change specifications without prior notice.

Los datos técnicos están sujetos a posibles variaciones a posibles variaciones que serán actualizadas periódicamente en las fichas técnicas del producto, disponibles en la web. The technical data are subject to possible variations that will be updated periodically in the technical data sheets of the product, which are available on the website.



Undercounter refrigerator

Serie
GN1/1 700
Series

REFRIGERACIÓN



Refrigeración

Sistema de **ventilación y condensación frontal**.
Bandeja evaporativa sin resistencias eléctricas.
Nuevo sistema **Monoblock**.
Unidades sobredimensionadas y eficientes

REFRIGERATION

Refrigeration

Front-breathing ventilation system.
Evaporative tray without electrical heaters.
New **Monoblock** refrigeration system.
Oversized and efficient units

BMGN 1960 II



BMGN

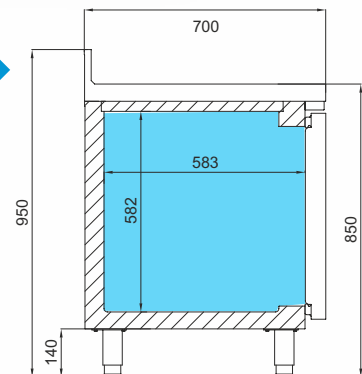

BMGN 1470 II

1468 x 700 x 850 mm.
Temp. -2°C/+8°C
C. Clima. 5 / 40°C
230V/1ph/50Hz



BMGN 1960 II

1960 x 700 x 850 mm.
Temp. -2°C/+8°C
C. Clima. 5 / 40°C
230V/1ph/50Hz



BMGN 2450 II

2452 x 700 x 850 mm.
Temp. -2°C/+8°C
C. Clima. 5 / 40°C
230V/1ph/50Hz

Opcional / Optional

Parrilla / Wire shelf [502X12]
Juego de guías / Slides [GUIAC0115530, GUIAC0215530]
Cerradura / Lock [506X209; 506X210]
Grupo lado contrario / Group opposite side [L]
Ruedas / Casters [705X16=2; 705X17=2]
Sin peto trasero / Without backsplash
115V/1ph/60Hz
230V/1ph/60Hz

Fotografías no contractuales / Non contractual pictures.

Características técnicas y constructivas sujetas a variación sin previo aviso / We reserve the right to change specifications without prior notice.

Los datos técnicos están sujetos a posibles variaciones que serán actualizadas periódicamente en las fichas técnicas del producto, disponibles en la web.

The technical data are subject to possible variations that will be updated periodically in the technical data sheets of the product, which are available on the website.





Mesa de congelación



Serie
GN1/1 700
Series

2

CARACTERÍSTICAS TÉCNICAS



Estructura

Estructura compacta totalmente **inyectada**.
Aislamiento de poliuretano de espesor 70 mm., inyectado a alta presión libre de CFC's con densidad 40 Kg/m³, Zero ODP and Low GWP.



Nuevo diseño de puertas

Nuevo diseño de **puertas con tirador de doble agarre**. Además, están **dotadas con bisagras** para un retorno automático y presión permanente durante el cierre. El retorno automático queda libre cuando la apertura supera los 95°. Incluyen **burlete plano** "cleanless" de cuatro cámaras fácilmente desmontables.

TECHNICAL CHARACTERISTICS

Structure

Compact **structure** totally **injected**.
Polyurethane insulation 70 mm thick, injected at high pressure free of CFC's with density 40 Kg / m³, Zero ODP and Low GWP.

New door design

New design of **doors with double grip handle**. **Doors equipped with hinges** for automatic return and permanent pressure during closing. The automatic return is free when the opening exceeds 95°. They include **four-chamber** "cleanless" flat door gasket easily removable

BMGN 1960 BT

Gastronorm 1/1



Más detalles
y ficha técnica en:



Versión español

More details and
technical sheet:



English version



Circulación optimizada del aire
Optimal air flow

Sistema de ventilación de condensación frontal
Front breathing condensation system

MOD.



Acero inox
Stainless Steel
(EXT/INT)



Espesor
Thickness
(MM)



Capacidad
Capacity
(L)



Puertas
Doors



Nº parrillas J.
guías
No shelves /
Slides



Sistema de
frio
Cooling
System



Control digital
Digital control



Potencia
Power
(W)



Potencia
frigorífica
Cooling capacity
(W A -30°C)



Consumo
Consumption
(kWh/24h)



Clase
energética
Energy class



Refrigerante
Refrigerant

MOD.	Acero inox Stainless Steel (EXT/INT)	Espesor Thickness (MM)	Capacidad Capacity (L)	Puertas Doors	Nº parrillas J. guías No shelves / Slides	Sistema de frio Cooling System	Control digital Digital control	Potencia Power (W)	Potencia frigorífica Cooling capacity (W A -30°C)	Consumo Consumption (kWh/24h)	Clase energética Energy class	Refrigerante Refrigerant
BMGN 1470 BT	AISI 304	70	305	2	2/10 [325x530]	Ventilado Forced air	IP65	443	445	5,45	C	R-290
BMGN 1960 BT	AISI 304	70	465	3	3/15 [325x530]	Ventilado Forced air	IP65	532	540	7,71	D	R-290
BMGN 2450 BT	AISI 304	70	630	4	4/20 [325x530]	Ventilado Forced air	IP65	703	640	9,03	D	R-290

Fotografías no contractuales / Non contractual pictures.

Características técnicas y constructivas sujetas a variación sin previo aviso / We reserve the right to change specifications without prior notice.

Los datos técnicos están sujetos a posibles variaciones que serán actualizadas periódicamente en las fichas técnicas del producto, disponibles en la web. The technical data are subject to possible variations that will be updated periodically in the technical data sheets of the product, which are available on the website.



Undercounter freezer

Serie
GN1/1 700
Series

REFRIGERACIÓN



Refrigeración

Sistema de **ventilación y condensación frontal**.
Sistema de **evaporación forzada**.
Bandeja de plástico con **serpentin embutido**.
Ventiladores **electrónicos**.
Desescarche por **gas caliente**.
Válvula de expansión **termostática**.

REFRIGERATION

Refrigeration system

Front-breathing ventilation system.
Forced air evaporation system.
Evaporative tray **without electrical heaters**.
Electronics fans.
Hot gas defrost.
Thermostatic **expansion valve**.

BMGN 1470 BT



BMGN

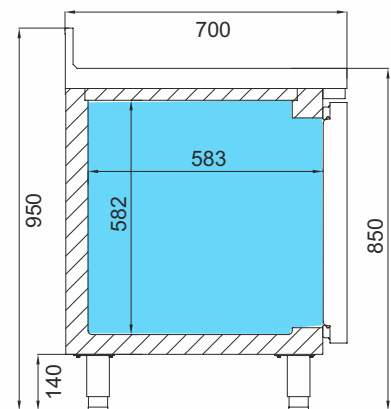

BMGN 1470 BT

1468 x 700 x 850 mm.
Temp. -18°C
C. Clima. 4 / 38°C
230V/1ph/50Hz



BMGN 1960 BT

1960 x 700 x 850 mm.
Temp. -18°C
C. Clima. 4 / 38°C
230V/1ph/50Hz



BMGN 2450 BT

2452 x 700 x 850 mm.
Temp. -18°C
C. Clima. 4 / 38°C
230V/1ph/50Hz

Opcional / Optional

Parrilla / Wire shelf [502X12]
Juego de guías / Slides [GUIAC0115530, GUIAC0215530]
Cerradura / Lock [506X209; 506X210]
Grupo lado contrario / Group opposite side [L]
Sin peto trasero / Without backsplash
115V/1ph/60Hz
230V/1ph/60Hz





Mesa refrigerada con cajones

Serie
GN1/1700
Series

2

CARACTERÍSTICAS TÉCNICAS



Estructura

Estructura compacta totalmente inyectada.
Aislamiento de poliuretano de espesor 70 mm., inyectado a alta presión libre de CFC's con densidad 40 Kg/m³, Zero ODP and Zero GWP.



Cajones

Cajones con guías telescópicas con salida mayorada y sistema de autocierre.

TECHNICAL CHARACTERISTICS

Structure

Compact structure totally injected.
Polyurethane insulation 70 mm thick, injected at high pressure free of CFC's with density 40 Kg / m³, Zero ODP and Zero GWP.

Drawers

Drawers with full extension slides and self closing system.

BMGN 1470



Más detalles
y ficha técnica en:



Versión español

More details and
technical sheet:



English version

MOD.	Descripción Description	Código Code	Precio Price
BMGN II, F, GR ,EN	Kit 2 cajones BMGN 1/2 x 200 2 Drawers kit BMGN 1/2 x 200	[JCAJ17GN1/2]	
BMGN II, F, GR ,EN	Kit 3 cajones BMGN 1/3x100 3 Drawers kit BMGN 1/3x100	[JCAJ17GN1/3]	
BMGN II, F, GR ,EN	Kit 2 cajones BMGN 2/3x300 + BMGN 1/3x100 2 Drawers kit BMGN 2/3x300 + BMGN 1/3x100	[JCAJ17GN2/3]	

Fotografías no contractuales / Non contractual pictures.

Características técnicas y constructivas sujetas a variación sin previo aviso / We reserve the right to change specifications without prior notice.

Los datos técnicos están sujetos a posibles variaciones que serán actualizadas periódicamente en las fichas técnicas del producto, disponibles en la web.
The technical data are subject to possible variations that will be updated periodically in the technical data sheets of the product, which are available on the website.



Undercounter refrigerator with drawers

Serie **GN1/1 700**
Series

REFRIGERACIÓN



Refrigeración

Sistema de ventilación y condensación frontal.
Bandeja evaporativa sin resistencias eléctricas.
Nuevo sistema Monoblock.

REFRIGERATION

Refrigeration system

Front-breathing ventilation system.
Evaporative tray without electrical resistances.
New Monoblock system.



BMGN 1/2 x 200

Kit 2 cajones
2 drawers kit

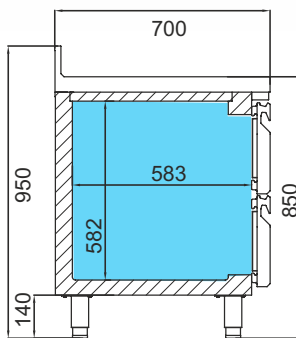

BMGN 2/3x300 + 1/3x100

Kit 2 cajones
2 drawers kit

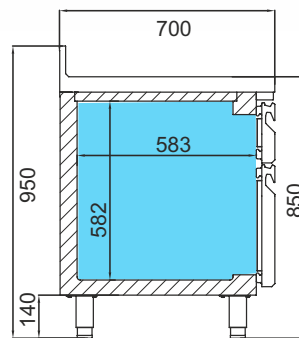

BMGN 1/3x100

Kit 3 cajones
3 drawers kit

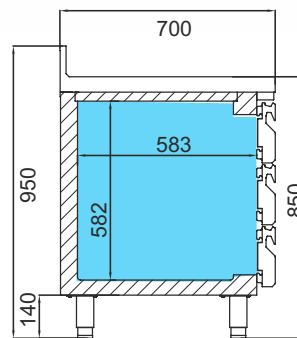

Medidas interiores cajones

Internal dimensions drawers

Cajón 1/3 / drawer
302 x 508 x 105

Cajón 1/2 / drawer
302 x 508 x 205

Cajón 2/3 / drawer
302 x 508 x 307





Mesa refrigerada con puertas de cristal Glass door undercounter refrigerator



Serie
GN1/1 700
Series

2

BMGN 1470 CR



Más detalles
y ficha técnica en:



Versión español

More details and
technical sheet:



English version

Doble cristal templado bajo emisivo
Tempered and low-e double pane glass. 4-27-4

Doble cristal templado bajo emisivo más carga Argón 4-27-4
Double tempered glass low-e + Argón 4-27-4

Opcional / Optional

- Parrilla tupida / Extradense wire shelf [502X62]
- Parrilla inoxidable / Stainless steel wire shelf [502X46]
- Juego de guías / Slides [GUIAC0115530, GUIAC0215530]
- Iluminación LED RGB con cambio de color [por puerta]
- LED Lighting RGB change of colour [per door]
- Cerradura / Lock [506X60]

BMGN CR

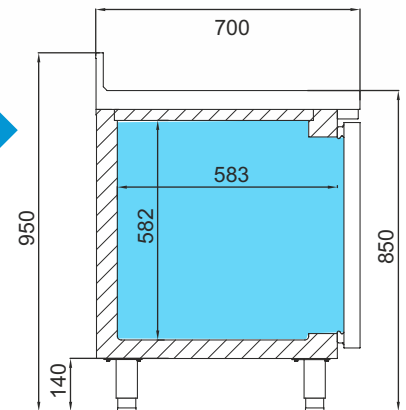

BMGN 1470 CR

1468 x 700 x 850 mm.
Temp. +2°C/+6°C
C. Clima. 4 / 38°C
230V/1ph/50Hz



BMGN 1960 CR

1960 x 700 x 850 mm.
Temp. +2°C/+6°C
C. Clima. 4 / 38°C
230V/1ph/50Hz



BMPP 2450 CR

2452 x 700 x 850 mm.
Temp. +2°C/+6°C
C. Clima. 4 / 38°C
230V/1ph/50Hz

MOD.



Acero inox
Stainless Steel
(EXT/INT)



Espesor
Thickness
(MM)



Capacidad
Capacity
(L)



Puertas
Doors



Nº parrillas J. guías
No shelves /
Slides



Sistema de frío
Cooling System



Control digital
Digital control



Led



Potencia
Power
(W)



Potencia frigorífica
Cooling capacity
(W A -10°C)



Refrigerante
Refrigerant

	Acero inox Stainless Steel (EXT/INT)	Espesor Thickness (MM)	Capacidad Capacity (L)	Puertas Doors	Nº parrillas J. guías No shelves / Slides	Sistema de frío Cooling System	Control digital Digital control	Led	Potencia Power (W)	Potencia frigorífica Cooling capacity (W A -10°C)	Refrigerante Refrigerant
BMGN 1470 CR	AISI 304	70	305	2	2/10 [325x530]	Ventilado Forced air	IP65	✓	457	690	R-290
BMGN 1960 CR	AISI 304	70	465	3	3/15 [325x530]	Ventilado Forced air	IP65	✓	462	690	R-290
BMGN 2450 CR	AISI 304	70	630	4	4/20 [325x530]	Ventilado Forced air	IP65	✓	467	690	R-290

Fotografías no contractuales / Non contractual pictures.

Características técnicas y constructivas sujetas a variación sin previo aviso / We reserve the right to change specifications without prior notice.

Los datos técnicos están sujetos a posibles variaciones que serán actualizadas periódicamente en las fichas técnicas del producto, disponibles en la web.
The technical data are subject to possible variations that will be updated periodically in the technical data sheets of the product, which are available on the website.





Mesa refrigerada con fregadero

Sink undercounter refrigerator



Serie
GN1/1 700
Series

MESAS
UNDERCOUNTERS

BMGN 1960 F



Más detalles
y ficha técnica en:



Versión español

More details and
technical sheet:



English version

Opcional / Optional

- Parrilla / Wire shelf [502X12]
- Juego de guías / Slides [GUIAC0115530; GUIAC0215530]
- Cerradura / Lock [506X209; 506X210]
- Grupo lado contrario / Group opposite side [L]

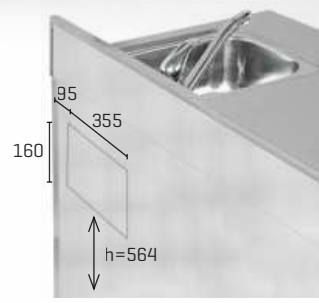
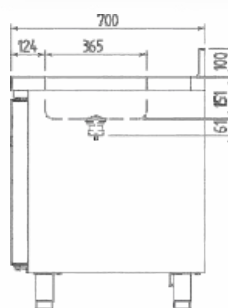

F= Fregadero / Sink
BMGN 1470 F

1468 x 700 x 850 mm.
Temp. -2°C/+8°C
C. Clima. 5 / 40°C
230V/1ph/50Hz



BMGN 1960 F

1960 x 700 x 850 mm.
Temp. -2°C/+8°C
C. Clima. 5 / 40°C
230V/1ph/50Hz



BMGN 2450 F

2452 x 700 x 850 mm.
Temp. -2°C/+8°C
C. Clima. 5 / 40°C
230V/1ph/50Hz

MOD.



Acero inox
Stainless Steel
[EXT/INT]



Espesor
Thickness
(MM)



Capacidad
Capacity
(L)



Puertas
Doors



Nº parrillas J.
guías
No shelves /
Slides



Sistema de
frío
Cooling
System



Control digital
Digital control



Potencia
Power
(W)



Potencia
frigorífica
Cooling capacity
(W A -10°C)



Consumo
Consumption
(kWh/24h)



Clase
energética
Energy class



Refrigerante
Refrigerant

MOD.	Acero inox Stainless Steel [EXT/INT]	Espesor Thickness (MM)	Capacidad Capacity (L)	Puertas Doors	Nº parrillas J. guías No shelves / Slides	Sistema de frío Cooling System	Control digital Digital control	Potencia Power (W)	Potencia frigorífica Cooling capacity (W A -10°C)	Consumo Consumption (kWh/24h)	Clase energética Energy class	Refrigerante Refrigerant
BMGN 1470 F	AISI 304	70	305	2	2/10 [325x530]	Ventilado Forced air	IP65	263	343	1,50	A	R-290
BMGN 1960 F	AISI 304	70	465	3	3/15 [325x530]	Ventilado Forced air	IP65	448	690	1,95	A	R-290
BMGN 2450 F	AISI 304	70	630	4	4/20 [325x530]	Ventilado Forced air	IP65	448	690	2,25	A	R-290

Fotografías no contractuales / Non contractual pictures.

Características técnicas y constructivas sujetas a variación sin previo aviso / We reserve the right to change specifications without prior notice.

Los datos técnicos están sujetos a posibles variaciones que serán actualizadas periódicamente en las fichas técnicas del producto, disponibles en la web.

The technical data are subject to possible variations that will be updated periodically in the technical data sheets of the product, which are available on the website.





Mesa refrigerada pre-instalada

Serie
GN1/1 700
Series

2

CARACTERÍSTICAS TÉCNICAS



Estructura

Estructura compacta totalmente **inyectada**.
Aislamiento de poliuretano de espesor 70 mm., inyectado a alta presión libre de CFC's con densidad 40 Kg/m³, Zero ODP and Low GWP.



Nuevo diseño de puertas

Nuevo diseño de **puertas con tirador de doble agarre**. Además, están dotadas con **bisagras para un retorno automático** y presión permanente durante el cierre. El retorno automático queda libre cuando la apertura supera los 95°. Incluyen burlete plano "cleanless" de cuatro cámaras fácilmente desmontables.

TECHNICAL CHARACTERISTICS

Structure

Compact **structure** totally **injected**.
Polyurethane insulation 70 mm thick, injected at high pressure free of CFC's with density 40 Kg / m³, Zero ODP and Low GWP.

New door design

New design of **doors with double grip handle**. **Doors equipped with hinges for automatic return** and permanent pressure during closing. The automatic return is free when the opening exceeds 95°. They include four-chamber "cleanless" flat door gasket easily removable.

BMGN 1470 GR



Más detalles y ficha técnica en:



Versión español

More details and technical sheet:



English version

Posibilidad de acceso frontal y lateral para una mejor manipulación.
Front and lateral access for better handling

Aumentan en su largo 8 cm. para una mejor manipulación.
They increase in their length 8 cm. for better handling.

MOD.



Acero inox
Stainless Steel
(EXT/INT)



Espesor
Thickness
(MM)



Capacidad
Capacity
(L)



Puertas
Doors



Nº parrillas J. guías
No shelves /
Slides



Sistema de frío
Cooling System



Control digital
Digital control



Potencia frigorífica
Cooling capacity
(W A -10°C -30°C)
recomendada

MOD.	Acero inox Stainless Steel (EXT/INT)	Espesor Thickness (MM)	Capacidad Capacity (L)	Puertas Doors	Nº parrillas J. guías No shelves / Slides	Sistema de frío Cooling System	Control digital Digital control	Potencia frigorífica Cooling capacity (W A -10°C -30°C) recomendada
BMGN 1470 GR	AISI 304	70	305	2	2/10 [325x530]	Ventilado Forced air	IP65	343
BMGN 1470 GRBT	AISI 304	70	305	2	2/10 [325x530]	Ventilado Forced air	IP65	445
BMGN 1960 GR	AISI 304	70	465	3	3/15 [325x530]	Ventilado Forced air	IP65	690
BMGN 1960 GRBT	AISI 304	70	465	3	3/15 [325x530]	Ventilado Forced air	IP65	540
BMGN 2450 GR	AISI 304	70	630	4	4/20 [325x530]	Ventilado Forced air	IP65	690
BMGN 2450 GRBT	AISI 304	70	630	4	4/20 [325x530]	Ventilado Forced air	IP65	640

Fotografías no contractuales / Non contractual pictures.

Características técnicas y constructivas sujetas a variación sin previo aviso / We reserve the right to change specifications without prior notice.

Los datos técnicos están sujetos a posibles variaciones que serán actualizadas periódicamente en las fichas técnicas del producto, disponibles en la web. The technical data are subject to possible variations that will be updated periodically in the technical data sheets of the product, which are available on the website.



Remote undercounter refrigerator

Serie
GN1/1 700
Series

MESAS
UNDERCOUNTERS

REFRIGERACIÓN



Refrigeración

Tubo conexión del evaporador de 3/8" [No se incluye capilar].
Sistema de **evaporación forzada**.
Desescarche por **gas caliente (GRBT)**.

REFRIGERATION

Refrigeration system

Supplied with 3/8" connection pipes for the evaporator.
Forced-air evaporator.
Hot gas defrost (GRBT).

BMGN 1960 GR



Posibilidad de acceso frontal y lateral para una mejor manipulación.
Front and lateral access for better handling

22cm



BMGN 1470 GR

1240 x 700 x 850 mm.
Temp. -2°C/+8°C
230V/1ph/50Hz

Opcional / Optional

Válvula de expansión [especificar refrigerante]
Expansion valve [specify refrigerant]
Parrilla / Wire shelf [502X12]
Juego de guías / Slides [GUIAC0115530; GUIAC0215530]
Puerta de cristal [unidad]
Glass door [unit] [PUE17IDGN/PUE17IIGN]
Cerradura / Lock [506X209; 506X210]
115V/1ph/60Hz
230V/1ph/60Hz

BMGN

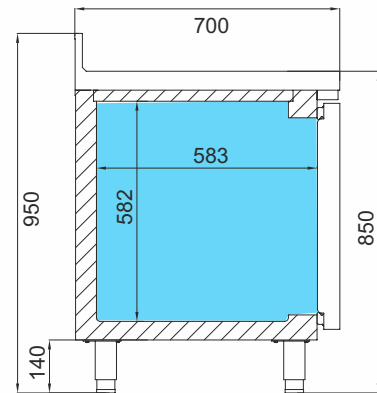

BMGN 1470 GRBT

1240 x 700 x 850 mm.
Temp. -18°C
230V/1ph/50Hz



BMGN 1960 GR

1732 x 700 x 850 mm.
Temp. -2°C/+8°C
230V/1ph/50Hz



BMGN 1960 GRBT

1732 x 700 x 850 mm.
Temp. -18°C
230V/1ph/50Hz



BMGN 2450 GR

2224 x 700 x 850 mm.
Temp. -2°C/+8°C
230V/1ph/50Hz



BMGN 2450 GRBT

2224 x 700 x 850 mm.
Temp. -18°C
230V/1ph/50Hz

Fotografías no contractuales / Non contractual pictures.

Características técnicas y constructivas sujetas a variación sin previo aviso / We reserve the right to change specifications without prior notice.

Los datos técnicos están sujetos a posibles variaciones que serán actualizadas periódicamente en las fichas técnicas del producto, disponibles en la web.

The technical data are subject to possible variations that will be updated periodically in the technical data sheets of the product, which are available on the website.





Mesa refrigerada central puertas a dos caras



Serie
GN1/1700
Series

CARACTERÍSTICAS TÉCNICAS

TECHNICAL CHARACTERISTICS



Estructura

Estructura compacta totalmente **inyectada**.

Aislamiento de poliuretano de espesor 70 mm., **inyectado a alta presión** libre de CFC's con densidad 40 Kg/m³, Zero ODP and Zero GWP.



Nuevo diseño de puertas

Nuevo diseño de **puertas con tirador de doble agarre**. Además, están dotadas con bisagras para un retorno automático y presión permanente durante el cierre. El retorno automático queda libre cuando la apertura supera los 95°. Incluyen burlete plano "cleanless" de cuatro cámaras fácilmente desmontables.

Structure

Compact structure totally **injected**.

Polyurethane insulation 70 mm thick, injected at high pressure free of CFC's with density 40 Kg / m³, Zero ODP and Zero GWP.

New door design

New design of **doors with double grip handle**. **Doors equipped with hinges** for automatic return and permanent pressure during closing. The automatic return is free when the opening exceeds 95°. They include four-chamber "cleanless" flat door gasket easily removable.

BMGN 1470 PDC



Más detalles
y ficha técnica en:



Versión español

More details and
technical sheet:



English version

MOD.



Acero inox
Stainless Steel
[EXT/INT]



Espesor
Thickness
[MM]



Capacidad
Capacity
[L]



Puertas
Doors



Nº parrillas J.
guías
No shelves /
Slides



Sistema de
frío
Cooling
System



Control digital
Digital control



Potencia
Power
[W]



Potencia
frigorífica
Cooling capacity
[W A -10°C]



Consumo
Consumption
[kWh/24h]



Clase
energética
Energy class



Refrigerante
Refrigerant

MOD.	Acero inox Stainless Steel [EXT/INT]	Espesor Thickness [MM]	Capacidad Capacity [L]	Puertas Doors	Nº parrillas J. guías No shelves / Slides	Sistema de frío Cooling System	Control digital Digital control	Potencia Power [W]	Potencia frigorífica Cooling capacity [W A -10°C]	Consumo Consumption [kWh/24h]	Clase energética Energy class	Refrigerante Refrigerant
BMGN 1470 PDC	AISI 304	70	290	4	2/10 [325x530]	Ventilado Forced air	IP65	263	343	1,50	A	R-290
BMGN 1960 PDC	AISI 304	70	440	6	3/15 [325x530]	Ventilado Forced air	IP65	448	690	1,95	A	R-290

Fotografías no contractuales / Non contractual pictures.

Características técnicas y constructivas sujetas a variación sin previo aviso / We reserve the right to change specifications without prior notice.

Los datos técnicos están sujetos a posibles variaciones que serán actualizadas periódicamente en las fichas técnicas del producto, disponibles en la web.
The technical data are subject to possible variations that will be updated periodically in the technical data sheets of the product, which are available on the website.



Pass thru undercounter refrigerator

Serie
GN1/1 700
Series

REFRIGERACIÓN



Refrigeración

Sistema de **ventilación y condensación frontal**.
Bandeja evaporativa sin resistencias eléctricas.
Nuevo sistema **Monoblock**.

REFRIGERATION

Refrigeration

Front-breathing ventilation system.
Evaporative tray without electrical heaters.
New **Monoblock** refrigeration system.



BMGN 1470 PDC

1468 x 700 x 850 mm.
Temp. -2°C/+8°C
C. Clima. 5 / 40°C
230V/1ph/50Hz



BMGN 1960 PDC

1960 x 700 x 850 mm.
Temp. -2°C/+8°C
C. Clima. 5 / 40°C
230V/1ph/50Hz

Opcional / Optional

- Puerta de cristal [unidad]
Glass door [unit] [PUE17IDGN/PUE17IIGN]
- Parrilla / Wire shelf [502X12]
- Parrilla inoxidable/Stainless steel wire shelf [502X46]
- Juego de guías / Slides [GUIACO3505]
- Cerradura / Lock [506X209; 506X210]
- 115V/1ph/60Hz
- 230V/1ph/60Hz





Mesa refrigerada para ensaladas



Serie
GN1/1 700
Series

2

CARACTERÍSTICAS TÉCNICAS

TECHNICAL CHARACTERISTICS



Encimera EN

Refrigeración estática superior.

Importante: Las bandejas deben contener producto previamente refrigerado.

Worktop EN [Salads]

Upper **static refrigeration.**

Important: The trays should contain previously refrigerated product.



Nuevo diseño de puertas

Nuevo diseño de **puertas con tirador de doble agarre**. Además, están dotadas con bisagras para un retorno automático y presión permanente durante el cierre. El retorno automático queda libre cuando la apertura supera los 95°. Incluyen burlete plano "cleanless" de cuatro cámaras fácilmente desmontables.

New door design

New design of **doors with double grip handle**. Doors equipped with **hinges** for automatic return and permanent pressure during closing. The automatic return is free when the opening exceeds 95°. They include four-chamber "cleanless" flat door gasket easily removable.

BMGN 1470 EN



Refrigeración estática en la cuba
Static cooling in the tank

Más detalles y ficha técnica en:

More details and technical sheet:



Versión español



English version



Opcional / Optional

BMGN 1470 EN

[501X13] = 1 [501X11] = 6



MOD.



Acero inox
Stainless Steel
[EXT/INT]



Espesor
Thickness
[MM]



Capacidad
Capacity
[L]



Puertas
Doors



Nº parrillas J. guías
No shelves /
Slides



Sistema de frío
Cooling System



Control digital
Digital control



Potencia
Power
[W]



Potencia frigorífica
Cooling capacity
[W A -10°C]



Refrigerante
Refrigerant

MOD.	Acero inox Stainless Steel [EXT/INT]	Espesor Thickness [MM]	Capacidad Capacity [L]	Puertas Doors	Nº parrillas J. guías No shelves / Slides	Sistema de frío Cooling System	Control digital Digital control	Potencia Power [W]	Potencia frigorífica Cooling capacity [W A -10°C]	Refrigerante Refrigerant
BMGN 1470 EN	AISI 304	70	305	2	2/10 [325x530]	Ventilado Forced air	IP65	263	343	R-290
BMGN 1960 EN	AISI 304	70	465	3	3/15 [325x530]	Ventilado Forced air	IP65	448	690	R-290

Fotografías no contractuales / Non contractual pictures.

Características técnicas y constructivas sujetas a variación sin previo aviso / We reserve the right to change specifications without prior notice.

Los datos técnicos están sujetos a posibles variaciones que serán actualizadas periódicamente en las fichas técnicas del producto, disponibles en la web. The technical data are subject to possible variations that will be updated periodically in the technical data sheets of the product, which are available on the website.



Salad prep refrigerator table

Serie
GN1/1 700
Series

MESAS
UNDERCOUNTERS

REFRIGERACIÓN



Refrigeración

Sistema de **ventilación y condensación frontal**.
Bandeja evaporativa sin resistencias eléctricas.
Nuevo sistema **Monoblock**.

REFRIGERATION

Refrigeration

Front-breathing ventilation system.
Evaporative tray without electrical heaters.
New **Monoblock** refrigeration system.

BMGN 1960 EN



Opcional / Optional

BMGN 1960 EN

[501X13] = 1 [501X11] = 9



BMGN EN

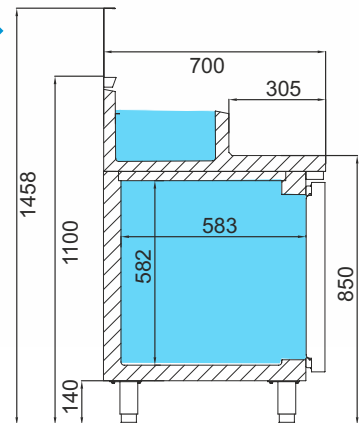

BMGN 1470 EN

1468 x 700 x 850/1100 mm.
Temp. 0°/+6°C.
C. Clima. 4 / 38°C
230V/1ph/50Hz



BMGN 1960 EN

1960 x 700 x 850/1100 mm.
Temp. 0°/+6°C.
C. Clima. 4 / 38°C
230V/1ph/50Hz

Opcional / Optional

Parrilla / Wire shelf [502X12]
Juego de guías / Slides [GUIAC0115530; GUIAC0215530]
Cerradura / Lock [506X209; 506X210]
Ruedas / Casters [705X16=2; 705X17=2]
115V/1ph/60Hz
230V/1ph/60Hz

Fotografías no contractuales / Non contractual pictures.

Características técnicas y constructivas sujetas a variación sin previo aviso / We reserve the right to change specifications without prior notice.

Los datos técnicos están sujetos a posibles variaciones que serán actualizadas periódicamente en las fichas técnicas del producto, disponibles en la web.

The technical data are subject to possible variations that will be updated periodically in the technical data sheets of the product, which are available on the website.





Mesa refrigerada pizza



Serie
GN1/1700
Series

2

CARACTERÍSTICAS TÉCNICAS



Estructura

Estructura compacta totalmente **inyectada**.
Aislamiento de poliuretano de espesor 70 mm., **inyectado a alta presión** libre de CFC's con densidad 40 Kg/m³, Zero ODP and Zero GWP.
Encimera de granito.



Diseño de puertas

Diseño de **puertas con tirador de doble agarre**. Además, están dotadas con bisagras para un retorno automático y presión permanente durante el cierre. El retorno automático queda libre cuando la apertura supera los 95°. Incluyen burlete plano "cleanless" de cuatro cámaras fácilmente desmontables [MPG].

TECHNICAL CHARACTERISTICS

Structure

Compact **structure** totally **injected**.
Polyurethane insulation 70 mm thick, injected at high pressure free of CFC's with density 40 Kg / m³, Zero ODP and Zero GWP.
Granite worktop.

Door design

Design of **doors with double grip handle**. **Doors equipped with hinges** for automatic return and permanent pressure during closing. The automatic return is free when the opening exceeds 95°. They include four-chamber "cleanless" flat door gasket easily removable [MPG].

ME 1003 VIP

Granito
Granite worktop



Más detalles
y ficha técnica en:



Versión español

More details and
technical sheet:



English version

Opcional / Optional

MPG 1980

[501X13] = 1 [501X16] = 7



Opcional / Optional

MPG 1490 / ME 1003 VIP

[501X16] = 6

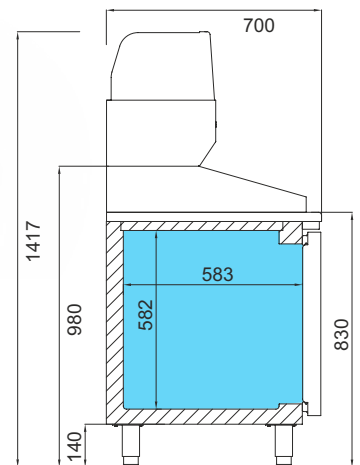

MPG

MOD.



Acero inox
Stainless Steel
(EXT/INT)



Espesor
Thickness
(MM)



Capacidad
Capacity
(L)



Puertas
Doors



Nº parrillas J. guías
No shelves /
Slides



Sistema de frío
Cooling System



Control digital
Digital control



Potencia
Power
(W)



Potencia
frigorífica
Cooling capacity
(W A -10°C)



Refrigerante
Refrigerant

Model	Acero inox Stainless Steel (EXT/INT)	Espesor Thickness (MM)	Capacidad Capacity (L)	Puertas Doors	Nº parrillas J. guías No shelves / Slides	Sistema de frío Cooling System	Control digital Digital control	Potencia Power (W)	Potencia frigorífica Cooling capacity (W A -10°C)	Refrigerante Refrigerant
MPG 1490	AISI 304	70	305+35	2	2/10 [325x530]	Ventilado/ Forced air Placa fría Cold plate	IP65	369	343	R-290
MPG 1980	AISI 304	70	465+54	3	3/15 [325x530]	Ventilado/ Forced air Placa fría Cold plate	IP65	553	690	R-290
ME 1003 VIP	AISI 304	55	355+35	3	3/9 [325x530]	Ventilado/ Forced air Placa fría Cold plate	IP65	503	690	R-290

Fotografías no contractuales / Non contractual pictures.

Características técnicas y constructivas sujetas a variación sin previo aviso / We reserve the right to change specifications without prior notice.

Los datos técnicos están sujetos a posibles variaciones que serán actualizadas periódicamente en las fichas técnicas del producto, disponibles en la web. The technical data are subject to possible variations that will be updated periodically in the technical data sheets of the product, which are available on the website.



Pizza undercounter refrigerator

Serie
GN1/1 700
Series

REFRIGERACIÓN



Refrigeración

Sistema de **ventilación y condensación frontal** / placa fría.
Bandeja evaporativa sin resistencias eléctricas.
Nuevo sistema **Monoblock** (MPG).

REFRIGERATION

Refrigeration

Front-breathing ventilation system / cold plate.
Evaporative tray without electrical heaters.
New **Monoblock** refrigeration system (MPG).

MPG 1980

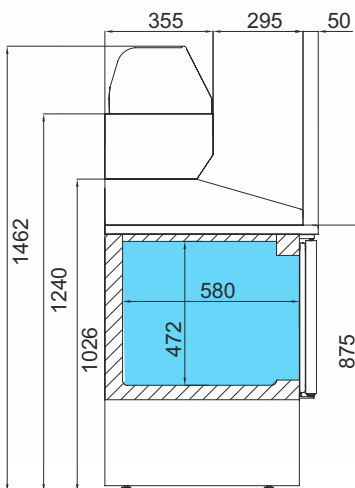

ME 1003 VIP

Opcional / Optional

Parrilla / Wire shelf [502X12]
Juego de guías / Slides [GUIAC0115530; GUIAC0215530]
Cerradura / Lock [506X209; 506X210]
Ruedas / Casters [705X16=2; 705X17=2] (MPG)
115V/1ph/60Hz
230V/1ph/60Hz



MPG 1490

1490 x 700 x 830/1417 mm.
Temp. 0°C/+6°C.
+4°C/+8°C
C. Clima. 4 / 38°C
230V/1ph/50Hz



MPG 1980

1980 x 700 x 830/1417 mm.
Temp. 0°C/+6°C.
+4°C/+8°C
C. Clima. 4 / 38°C
230V/1ph/50Hz



ME 1003 VIP

1490 x 700 x 885/1417 mm.
Temp. 0°C/+6°C.
+4°C/+8°C
C. Clima. 4 / 38°C
230V/1ph/50Hz





Mesa refrigerada para ensaladas



Serie
GN1/1 700
Series

2

CARACTERÍSTICAS TÉCNICAS



Estructura

Estructura compacta totalmente **inyectada**.
Aislamiento de poliuretano de espesor 70 mm., **inyectado a alta presión** libre de CFC's con densidad 40 Kg/m³, Zero ODP and Zero GWP.

TECHNICAL CHARACTERISTICS

Structure

Compact structure totally **injected**.
Polyurethane insulation 70 mm thick, **injected at high pressure** free of CFC's with density 40 Kg / m³, Zero ODP and Zero GWP.

ME 1000 BAN



Más detalles
y ficha técnica en:



Versión español

More details and
technical sheet:



English version

ME 1000 II



ME 1000 EN

[501X16] = 5



ME 1000 PIZZA

[501X11] = 6 [501X10] = 3



Opcional / Optional

ME 1000 BAN/KB

[501X11] = 6 [501X10] = 3

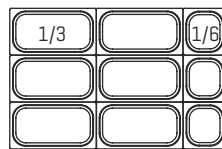

MOD.



Acero inox
Stainless Steel
(EXT/INT)



Espesor
Thickness
(MM)



Capacidad
Capacity
(L)



Puertas
Doors



Nº parrillas J. guías
No shelves /
Slides



Sistema de frío
Cooling System



Control digital
Digital control



Potencia
Power
(W)



Potencia
frigorífica
Cooling capacity
(W A -10°C)



Refrigerante
Refrigerant

MOD.	Acero inox Stainless Steel (EXT/INT)	Espesor Thickness (MM)	Capacidad Capacity (L)	Puertas Doors	Nº parrillas J. guías No shelves / Slides	Sistema de frío Cooling System	Control digital Digital control	Potencia Power (W)	Potencia frigorífica Cooling capacity (W A -10°C)	Refrigerante Refrigerant
ME 1000 BAN	AISI 304	55	230	2	2/6 [325x530]	Ventilado Forced air	IP65	263	343	R-290
ME 1000 EN	AISI 304	55	230	2	2/6 [325x530]	Ventilado Forced air	IP65	263	343	R-290
ME 1000 II	AISI 304	55	230	2	2/6 [325x530]	Ventilado Forced air	IP65	263	343	R-290
ME 1000 PIZZA	AISI 304	55	230	2	2/6 [325x530]	Ventilado Forced air	IP65	263	343	R-290
ME 1000 KB	AISI 304	55	230	2	2/6 [325x530]	Ventilado Forced air	IP65	263	343	R-290

Fotografías no contractuales / Non contractual pictures.

Características técnicas y constructivas sujetas a variación sin previo aviso / We reserve the right to change specifications without prior notice.

Los datos técnicos están sujetos a posibles variaciones que serán actualizadas periódicamente en las fichas técnicas del producto, disponibles en la web.
The technical data are subject to possible variations that will be updated periodically in the technical data sheets of the product, which are available on the website.



Salad prep refrigerator table

Serie
GN1/1 700
Series

MESAS
UNDERCOUNTERS

REFRIGERACIÓN



Refrigeración

Sistema de **condensación ventilada**.
Bandeja evaporativa sin resistencias eléctricas.

REFRIGERATION

Refrigeration

Ventilation condensation system.
Evaporative tray without electrical heaters.

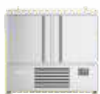

ME 1000 BAN

978 x 700 x 857 mm.
Temp. 0°C/+6°C.
C. Clima. 4 / 38°C
230V/1ph/50Hz



ME 1000 II

978 x 700 x 1050 mm.
Temp. 0°C/+6°C.
C. Clima. 5 / 40°C
230V/1ph/50Hz



ME 1000 PIZZA

978 x 700 x 865/1129 mm.
Temp. 0°C/+6°C.
C. Clima. 4 / 38°C
230V/1ph/50Hz



ME 1000 EN

978 x 700 x 885 mm.
Temp. 0°C/+6°C.
C. Clima. 4 / 38°C
230V/1ph/50Hz



ME 1000 KB

978 x 700 x 1125 mm.
Temp. 0°C/+6°C.
C. Clima. 4 / 38°C
230V/1ph/50Hz

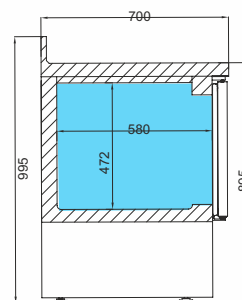

ME 1000 II

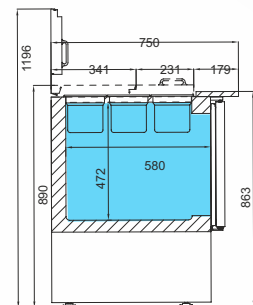

ME 1000 BAN

Opcional / Optional

Parrilla / Wire shelf [502X12]

Juego de guías / Slides [GUIA503X22; GUIA503X23]

Kit 2 cajones 1x1/2 + 1x1/3 [Modelo II] /
Drawers 1x1/2 + 1x1/3 [Model II] [JCAJ17ME1/2]

Puerta de cristal [unidad] / Glass door [unit] [PUE17IDME10/
PUE17IIME10]

Cerradura / Lock [506X209; 506X210]

115V/1ph/60Hz

230V/1ph/60Hz





Mesa refrigerada para ensaladas



Serie
GN1/1 700
Series

2

CARACTERÍSTICAS TÉCNICAS



Estructura

Estructura compacta totalmente **inyectada**.

Aislamiento de poliuretano de espesor 70 mm., inyectado a alta presión libre de CFC's con densidad 40 Kg/m³, Zero ODP and Zero GWP.

TECHNICAL CHARACTERISTICS

Structure

Compact **structure** totally **injected**.

Polyurethane insulation 70 mm thick, injected at high pressure free of CFC's with density 40 Kg / m³, Zero ODP and Zero GWP.



ME 1003 PIZZA

More details and technical sheet:



English version

Más detalles y ficha técnica en:



Versión español

Opcional / Optional

ME 1003 BAN/KB

[501X11] = 9 [501X10] = 6

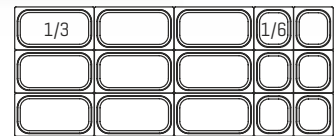

ME 1003 EN

[501X16] = 8



ME 1003 PIZZA

[501X11] = 2 [501X10] = 4



MOD.



Acero inox
Stainless Steel
(EXT/INT)



Espesor
Thickness
(MM)



Capacidad
Capacity
(L)



Puertas
Doors



Nº parrillas J. guías
No shelves /
Slides



Sistema de frío
Cooling System



Control digital
Digital control



Potencia
Power
(W)



Potencia frigorífica
Cooling capacity
(W A -10°C)



Refrigerante
Refrigerant

MOD.	Acero inox Stainless Steel (EXT/INT)	Espesor Thickness (MM)	Capacidad Capacity (L)	Puertas Doors	Nº parrillas J. guías No shelves / Slides	Sistema de frío Cooling System	Control digital Digital control	Potencia Power (W)	Potencia frigorífica Cooling capacity (W A -10°C)	Refrigerante Refrigerant
ME 1003 BAN	AISI 304	55	355	3	3/9 [325x530]	Ventilado Forced air	IP65	448	690	R-290
ME 1003 EN	AISI 304	55	355	3	3/9 [325x530]	Ventilado Forced air	IP65	448	690	R-290
ME 1003 II	AISI 304	55	355	3	3/9 [325x530]	Ventilado Forced air	IP65	448	690	R-290
ME 1003 PIZZA	AISI 304	55	355	3	3/9 [325x530]	Ventilado Forced air	IP65	448	690	R-290
ME 1003 KB	AISI 304	55	355	3	3/9 [325x530]	Ventilado Forced air	IP65	448	690	R-290

Fotografías no contractuales / Non contractual pictures.

Características técnicas y constructivas sujetas a variación sin previo aviso / We reserve the right to change specifications without prior notice.

Los datos técnicos están sujetos a posibles variaciones que serán actualizadas periódicamente en las fichas técnicas del producto, disponibles en la web. The technical data are subject to possible variations that will be updated periodically in the technical data sheets of the product, which are available on the website.



Salad prep refrigerator table

Serie
GN1/1 700
Series

MESAS
UNDERCOUNTERS

REFRIGERACIÓN



Refrigeración

Sistema de **condensación ventilada**.
Bandeja evaporativa sin resistencias eléctricas.

REFRIGERATION

Refrigeration

Ventilation condensation system.
Evaporative tray without electrical heaters.

ME 1003 BAN



ME 1000 KB



ME 1003 BAN

1460 x 700 x 885/1050 mm.
Temp. 0°C/+6°C.
C. Clima. 4 / 38°C
230V/1ph/50Hz



ME 1003 II

1460 x 700 x 885/1129 mm.
Temp. 0°C/+6°C.
C. Clima. 5 / 40°C
230V/1ph/50Hz



ME 1003 PIZZA

1460 x 700 x 867 mm.
Temp. 0°C/+6°C.
C. Clima. 4 / 38°C
230V/1ph/50Hz



ME 1003 EN

1460 x 700 x 885 mm.
Temp. 0°C/+6°C.
C. Clima. 4 / 38°C
230V/1ph/50Hz



ME 1003 KB

1460 x 700 x 1125 mm.
Temp. 0°C/+6°C.
C. Clima. 4 / 38°C
230V/1ph/50Hz

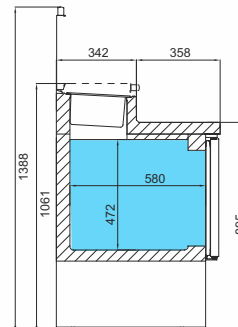

ME 1003 EN

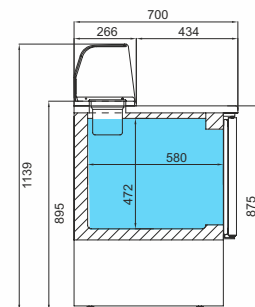

ME 1003 PIZZA

Opcional / Optional

Parrilla / Wire shelf [502X12]

Juego de guías / Slides [GUIA503X22; GUIA503X23]

Kit 2 cajones 1x1/2 + 1x1/3 [Modelo II] /
Drawers 1x1/2 + 1x1/3 [Model II] [JCAJ10ME1/2]

Puerta de cristal [unidad] / Glass door [unit] [PUE17IDME10/
PUE17IIME10]

Cerradura / Lock [506X209; 506X210]

115V/1ph/60Hz

230V/1ph/60Hz

Fotografías no contractuales / Non contractual pictures.

Características técnicas y constructivas sujetas a variación sin previo aviso / We reserve the right to change specifications without prior notice.

Los datos técnicos están sujetos a posibles variaciones que serán actualizadas periódicamente en las fichas técnicas del producto, disponibles en la web.

The technical data are subject to possible variations that will be updated periodically in the technical data sheets of the product, which are available on the website.

