

# 9. Vitrinas Supermarket Supermarket Cases

## HONGOS

Los hongos desempeñan un papel fundamental en la biodiversidad de los ecosistemas forestales y en la mitigación de del impacto del cambio climático.

## FUNGI

Fungi play a fundamental role in the biodiversity of forest ecosystems and in mitigating the impact of climate change.

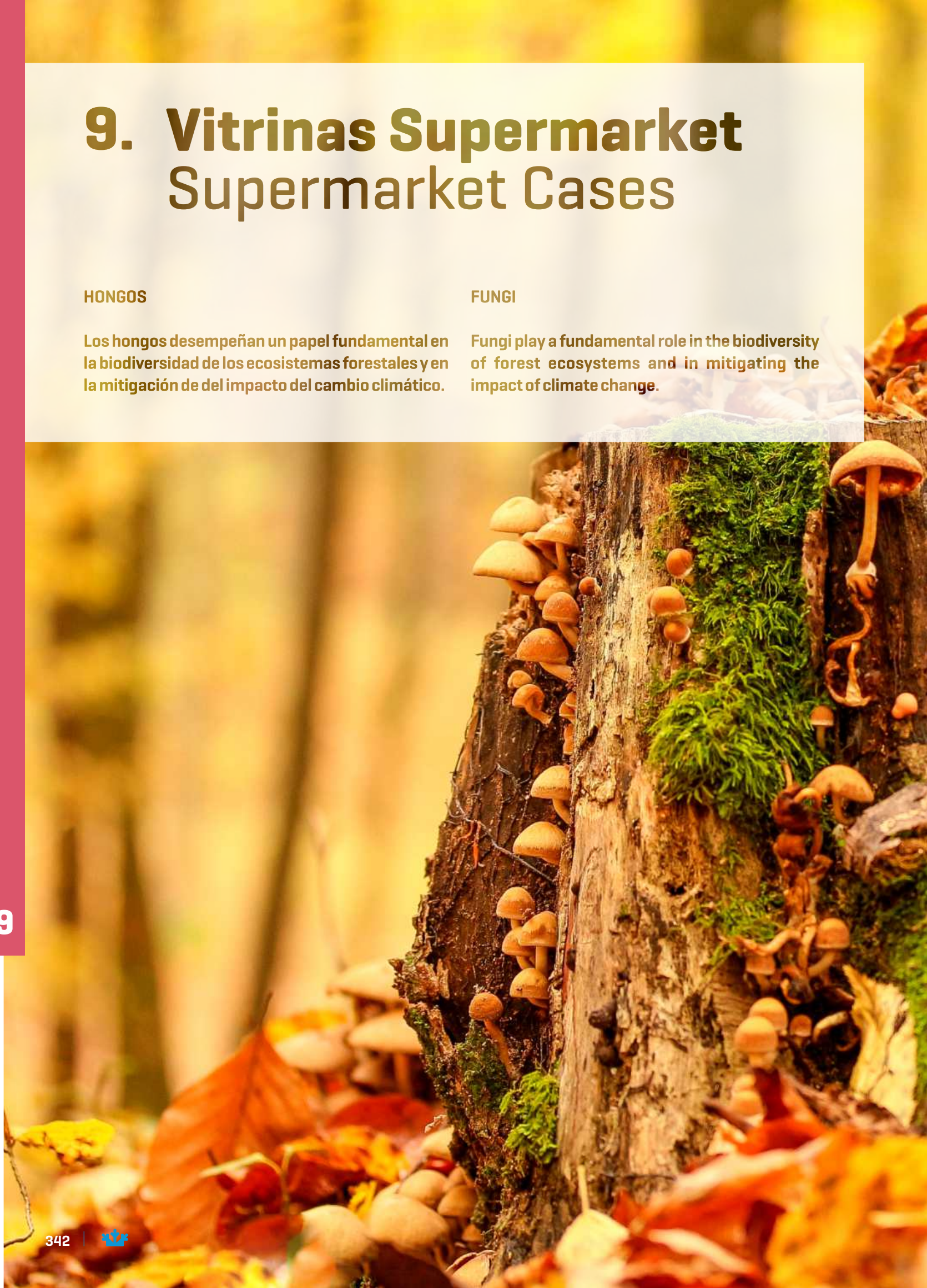





V. SUPERMARKET  
SUPERMARKET CASES





# Vitrina expositora modular frío ventilado Refrigerated modular display case



9

Fotografías no contractuales / Non contractual pictures.

Características técnicas y constructivas sujetas a variación sin previo aviso / We reserve the right to change specifications without prior notice.

Los datos técnicos están sujetos a posibles variaciones que serán actualizadas periódicamente en las fichas técnicas del producto, disponibles en la web.  
The technical data are subject to possible variations that will be updated periodically in the technical data sheets of the product, which are available on the website.





Serie  
**MADRID**  
Series



V. SUPERMARKET  
SUPERMARKET CASES



# Vitrina expositora modular frío ventilado

Serie  
**MADRID**  
Series

## CARACTERÍSTICAS TÉCNICAS

### Línea modular



Línea modular, combinación de módulos de **diferentes sistemas de refrigeración**. Módulos con o sin reserva refrigerada. Ángulos y mostradores para adaptar la línea a un espacio.



### Comprobación de fuga de gas

Todos las unidades condensadoras son **comprobados al 100%, en cámara de Helio** para la detección de la fuga de gas.



### Iluminación

Incorporación de **iluminación LED**, llegando a **reducir el consumo energético entre un 80% y 90%** Iluminación en todos los niveles y frente para realizar los productos.

## TECHNICAL CHARACTERISTICS

### Modular line

Combination of **different cooling system modules**: ventilated, half-static and static. Modules with or without cooled storage. Angles and counters to adapt the line to a space.

### Leak detection system

All condenser units are **tested 100%, in helium** chambers to refrigerant leak detections.

### Lighting

**LED lighting** incorporated, **reducing energetic consumption between 80% and 90%** respect to a traditional light bulb.

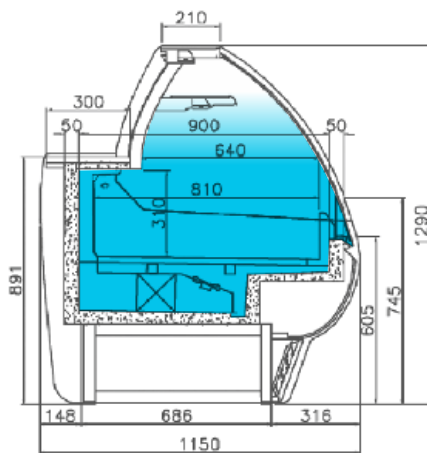

**VMD S (sin reserva)**  
(Whitout storage)

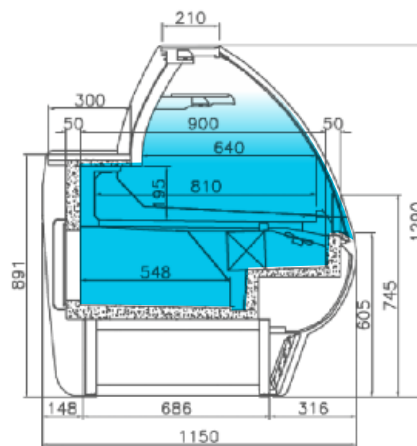

**VMD R (con reserva)**  
(Whit storage)



**Detalle reserva**  
Storage detail

### MOD.



**Costados**  
Sides  
(2)(mm)



**Potencia**  
Power  
(W)



**Capacidad**  
Capacity  
(L)



**Puertas**  
Doors



**Superficie**  
exposición  
(m<sup>2</sup>)



**Estantes**  
Shelving



**Compresor**  
Compressor  
(HP)



**Consumo**  
Consumption  
(kWh/24h)



**Potencia**  
frigorífica  
Cooling capacity  
(W A -10°C)



**Control**



**Refrigerante**  
Coolant

	Costados Sides (2)(mm)	Potencia Power (W)	Capacidad Capacity (L)	Puertas Doors	Superficie exposición (m <sup>2</sup> )	Estantes Shelving	Compresor Compressor (HP)	Consumo Consumption (kWh/24h)	Potencia frigorífica Cooling capacity (W A -10°C)	Control	Refrigerante Coolant
VMD 9 R/S	30+30	730	131	1	0,76	1	1/3	10,2	611	Digital	R-452
VMD 12 R/S	30+30	980	175	2	1,01	1	3/8	13,7	676	Digital	R-452
VMD 15 R/S	30+30	1030	219	2	1,27	1	5/8	14,4	1096	Digital	R-452
VMD 18 R/S	30+30	1260	263	3	1,52	1	3/4	17,6	1315	Digital	R-452
VMD 25 R/S	30+30	1520	350	4	2,03	1	1	21,3	1594	Digital	R-452
VMD 31 R/S	30+30	310	460	5	2,53	1	sin unidad without unity	4,3	2340	Digital	R-452
VMD 37 R/S	30+30	370	571	6	3,04	1	sin unidad without unity	5,2	2812	Digital	R-452

Fotografías no contractuales / Non contractual pictures.

Características técnicas y constructivas sujetas a variación sin previo aviso / We reserve the right to change specifications without prior notice.

Los datos técnicos están sujetos a posibles variaciones que serán actualizadas periódicamente en las fichas técnicas del producto, disponibles en la web. The technical data are subject to possible variations that will be updated periodically in the technical data sheets of the product, which are available on the website.





# Refrigerated modular display case

Serie  
**MADRID**  
Series

## REFRIGERACIÓN



### Refrigeración

#### Desescarche automático.

Sistema de **Condensación Ventilada**.

Sistema de **Evaporación Forzada**.

**Bandeja evaporativa en acero** inoxidable **con doble cuba**, una a gas caliente y otra con Resistencia eléctrica.

## REFRIGERATION

### Refrigeration

#### Automatic defrost.

**Ventilated condensation** system.

**Forced evaporation** system.

Stainless **steel evaporative tray with double vat**, one for hot gas and another with electrical heater.

VMD 25 R



[Decoración standard / Standard decoration]



VMD 9 R



VMD 12 R



VMD 15 R



VMD 18 R

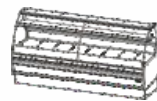

VMD 25 R

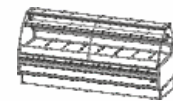

VMD 31 R\*

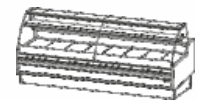

VMD 37 R\*

938x1150x1290 mm.	1250x1150x1290 mm.	1562x1150x1290 mm.	1875x1150x1290 mm.	2500x1150x1290 mm.	3125x1150x1290 mm.	3750x1150x1290 mm.
Temp. 0°C/+6°C	Temp. 0°C/+6°C	Temp. 0°C/+6°C	Temp. 0°C/+6°C	Temp. 0°C/+6°C	Temp. 0°C/+6°C	Temp. 0°C/+6°C
C. Clima. 4	C. Clima. 4	C. Clima. 4	C. Clima. 4	C. Clima. 4	C. Clima. 4	C. Clima. 4
230v/1 ph/50 Hz	230v/1 ph/50 Hz	230v/1 ph/50 Hz	230v/1 ph/50 Hz	230v/1 ph/50 Hz	230v/1 ph/50 Hz	230v/1 ph/50 Hz
VMD 9 S	VMD 12 S	VMD 15 S	VMD 18 S	VMD 25 S	VMD 31 S*	VMD 37 S*

**Medidas sin costados** Measures without sides

**\*Los modelos 31 y 37 [sin unidad condensadora o sin grupo]** Models 31 and 37 [without condensing unit or without group]

**Opciones y decoraciones** pág. 355

Options & decorations pag. 355

Fotografías no contractuales / Non contractual pictures.

Características técnicas y constructivas sujetas a variación sin previo aviso / We reserve the right to change specifications without prior notice.

Los datos técnicos están sujetos a posibles variaciones que serán actualizadas periódicamente en las fichas técnicas del producto, disponibles en la web.

The technical data are subject to possible variations that will be updated periodically in the technical data sheets of the product, which are available on the website.

www.infrico.com



351



# Vitrina expositora modular frío ventilado

Serie  
**MADRID**  
Series

VMD R

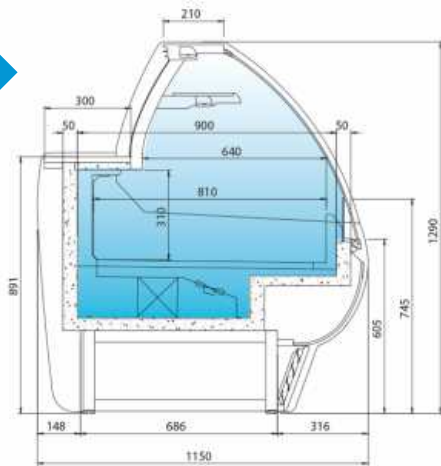

VMD S

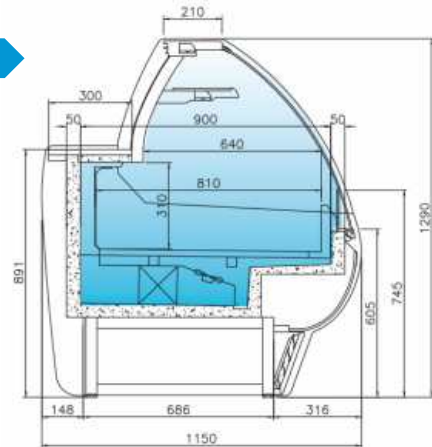



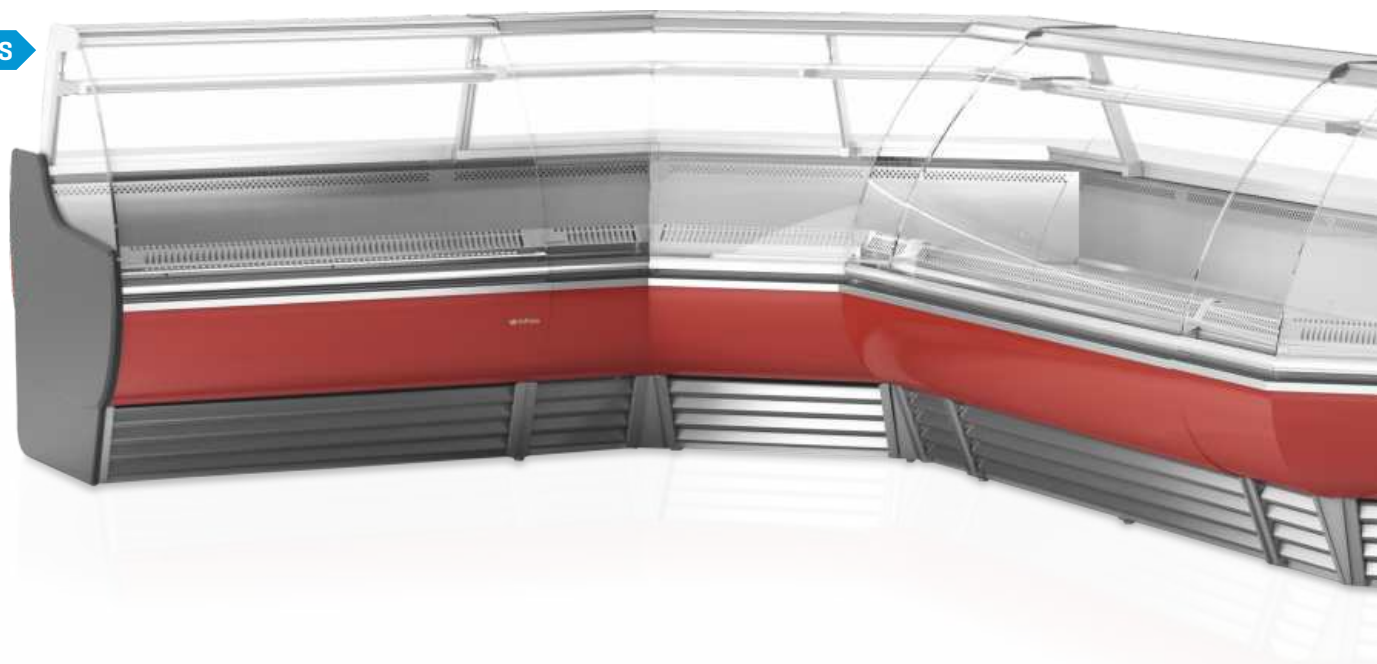











VMD 90 AA R/S



9

MOD.

	 Costados Sides (2)(mm)	 Potencia Power (W)	 Tensión Frecuencia Electrical (V/Hz)	 Capacidad Capacity (L)	 Puertas Doors	 Superficie exposición (m <sup>2</sup> )	 Estantes Shelving	 Compresor Compressor (HP)	 Led	 Consumo Consumption (kWh/24h)	 Evaporación Evaporation	 Potencia frigorífica Cooling capacity (W A -10°C)	 Control	 Refrigerante Coolant
VMD 90 AA R/S	30+30	990	230/50	-	-	1,15	1	5/8	✓	13,9	Forzada Forced	1096	Digital	R-452
VMD 45 AA R/S	30+30	670	230/50	-	-	0,63	1	3/8	✓	9,4	Forzada Forced	676	Digital	R-452
VMD 90 AC R/S	30+30	1060	230/50	-	-	1,49	1	3/4	✓	14,8	Forzada Forced	1315	Digital	R-452
VMD 45 AC R/S	30+30	740	230/50	-	-	0,75	1	1/2	✓	10,4	Forzada Forced	817	Digital	R-452

Fotografías no contractuales / Non contractual pictures.

Características técnicas y constructivas sujetas a variación sin previo aviso / We reserve the right to change specifications without prior notice.

Los datos técnicos están sujetos a posibles variaciones que serán actualizadas periódicamente en las fichas técnicas del producto, disponibles en la web. The technical data are subject to possible variations that will be updated periodically in the technical data sheets of the product, which are available on the website.



# Refrigerated modular display case

Serie  
**MADRID**  
Series

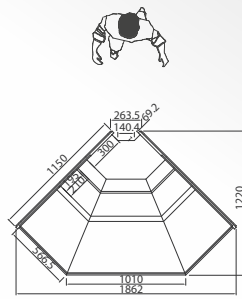

VMD 90 AA R

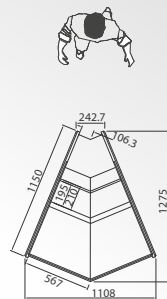

VMD 45 AA R

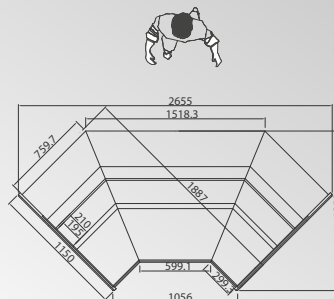

VMD 90 AC R

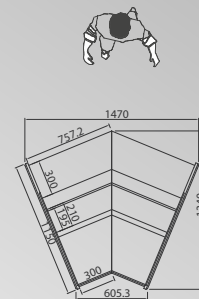

VMD 45 AC R

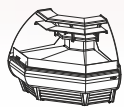
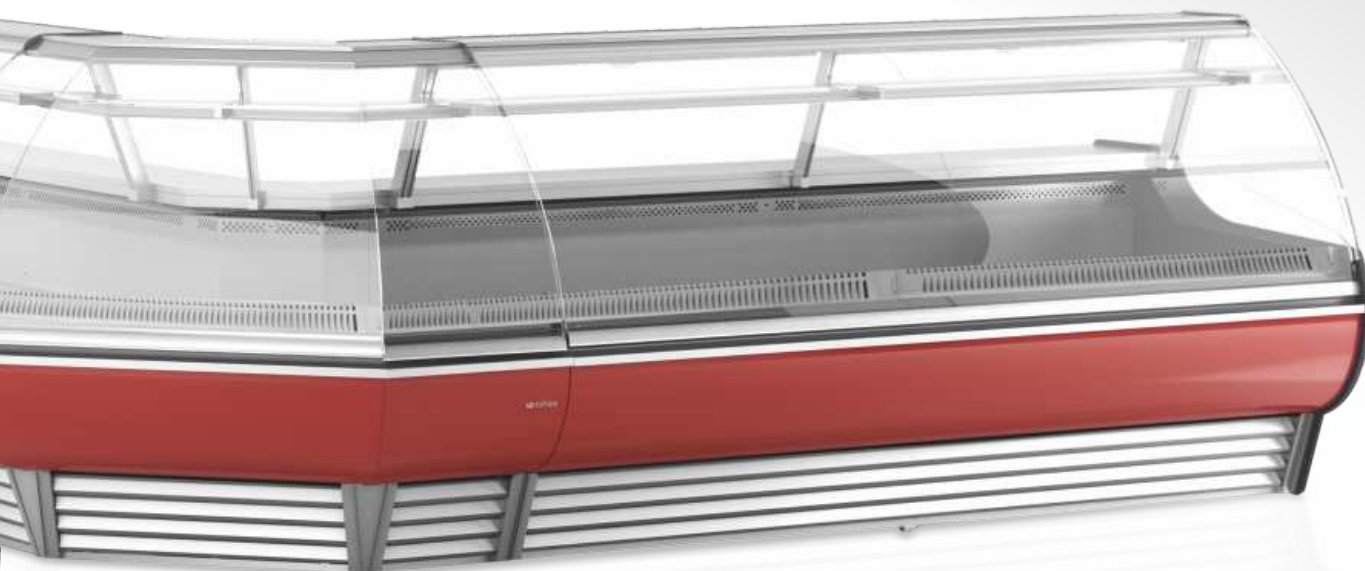

VMD 90 AA R



VMD 45 AA R



VMD 90 AC R



VMD 45 AC R

1326x1150x1290 mm.

Temp. 0°C/+6°C

C. Clima. 4

230v/1 ph/50 Hz

1108x1150x1290 mm.

Temp. 0°C/+6°C

C. Clima. 4

230v/1 ph/50 Hz

1887x1150x1290 mm.

Temp. 0°C/+6°C

C. Clima. 4

230v/1 ph/50 Hz

1470x1150x1290 mm.

Temp. 0°C/+6°C

C. Clima. 4

230v/1 ph/50 Hz

VMD 90 AA S

VMD 45 AA S

VMD 90 AC S

VMD 45 AC S

1326x1150x1290 mm.

Temp. 0°C/+6°C

C. Clima. 4

230v/1 ph/50 Hz

1108x1150x1290 mm.

Temp. 0°C/+6°C

C. Clima. 4

230v/1 ph/50 Hz

1887x1150x1290 mm.

Temp. 0°C/+6°C

C. Clima. 4

230v/1 ph/50 Hz

1470x1150x1290 mm.

Temp. 0°C/+6°C

C. Clima. 4

230v/1 ph/50 Hz

**MOD.**

**Puertas correderas traseras**  
Rear sliding doors

VMD 90 AA	(PUEV90AACT)
VMD 45 AA	(PUEV45AACT)
VMD 90 AC	(PUEV90ACCT)
VMD 45 AC	(PUEV45ACCT)

**Medidas sin costados** Measures without sides

Fotografías no contractuales / Non contractual pictures.

Características técnicas y constructivas sujetas a variación sin previo aviso / We reserve the right to change specifications without prior notice.

Los datos técnicos están sujetos a posibles variaciones que serán actualizadas periódicamente en las fichas técnicas del producto, disponibles en la web.

The technical data are subject to possible variations that will be updated periodically in the technical data sheets of the product, which are available on the website.







# Mueble caja mostrador

Serie  
**MADRID**  
Series

VMD 12 M



VMD 9 C



9

MOD.



Costados  
Sides  
[2][mm]



Superficie exposición  
[m<sup>2</sup>]

MOD.	Costados Sides [2][mm]	Superficie exposición [m <sup>2</sup> ]
VMD 9 C	30+30	0,55
VMD 12 M	30+30	0,74
VMD 15 M	30+30	0,92



VMD 9 C

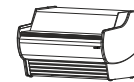

VMD 12 M



VMD 15 M

938 x 1150 x 906 mm. 1250 x 1150 x 906 mm. 1562 x 1150 x 906 mm.

**Medidas sin costados** Measures without sides

**Modelos 31 y 37 (sin unidad condensadora o sin grupo)**  
Models 31 and 37 (without condensing unit or without group)



# Counter case

Serie  
**MADRID**  
Series

VMD 25 R



Ral 9016  
Blanco / White

## Decoración Standard / Standar Decorations

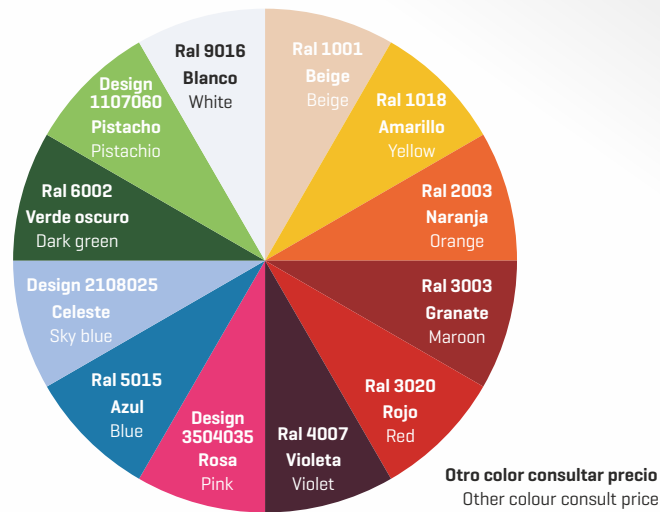

## Colores fuera de carta / Colors outside of letter

Color	Tipo Type	Incremento plazo de entrega Increase delivery time	Suplemento PVP [x pedido] PVP supplement [x order]
RAL	Epoxi	+10 días laborables/ Work days	
	Líquida/Liquid	+10 días laborables/ Work days	
NO RAL	Epoxi	Consultar/Consulter	Consultar/Consulter
	Líquida/Liquid	Consultar/Consulter	Consultar/Consulter

MOD.	Puertas correderas traseras Rear sliding doors	Cortinas traseras nocturnas Night curtains	Doble plano (Sin reserva) Double surface (Without strage)	Lacado frontal + costados Frontal lacqued + sides
VMD 9	[PUEV9CT]	[CCNV9]	[DPEXVMDBC9S]	[DFCVMDVBC]
VMD 12	[PUEV12CT]	[CCNV12]	[DPEXVMDBC12S]	[DFCVMDVBC]
VMD 15	[PUEV15CT]	[CCNV15]	[DPEXVMDBC15S]	[DFCVMDVBC]
VMD 18	[PUEV18CT]	[CCNV18]	[DPEXVMDBC18S]	[DFCVMDVBC]
VMD 25	[PUEV25CT]	[CCNV25]	[DPEXVMDBC25S]	[DFCVMDVBC]
VMD 31	[PUEV31CT]	[CCNV31]	[DPEXVMDBC31S]	[DFCVMDVBC]
VMD 37	[PUEV37CT]	[CCNV37]	[DPEXVMDBC37S]	[DFCVMDVBC]

Fotografías no contractuales / Non contractual pictures.

Características técnicas y constructivas sujetas a variación sin previo aviso / We reserve the right to change specifications without prior notice.

Los datos técnicos están sujetos a posibles variaciones que serán actualizadas periódicamente en las fichas técnicas del producto, disponibles en la web.

The technical data are subject to possible variations that will be updated periodically in the technical data sheets of the product, which are available on the website.

