



Vitrine d'exposition pour cafétéria et pâtisserie

Photos non contractuelles

À SOULIGNER



Plan de travail en COMPAC quartz blanc.
Vitres plates frontales (battantes) et latérales en sécurité.
Châssis en acier émaillé.
Décoration en DM hydrofuge laqué.

Arrière du meuble en tôle plastifiée.
Décoration frontale avec éclairage LED.
Plan d'exposition en acier traité époxy polyester.



Série
MAGNUS**À SOULIGNER**

Éclairage LED sur plan d'exposition.
Éclairage LED sur étagères.
Structure support verre profilés en aluminium anodisé .

Système de condensation ventilée.
Double bac d'évaporation.
Contrôle de la température finale de dégivrage.

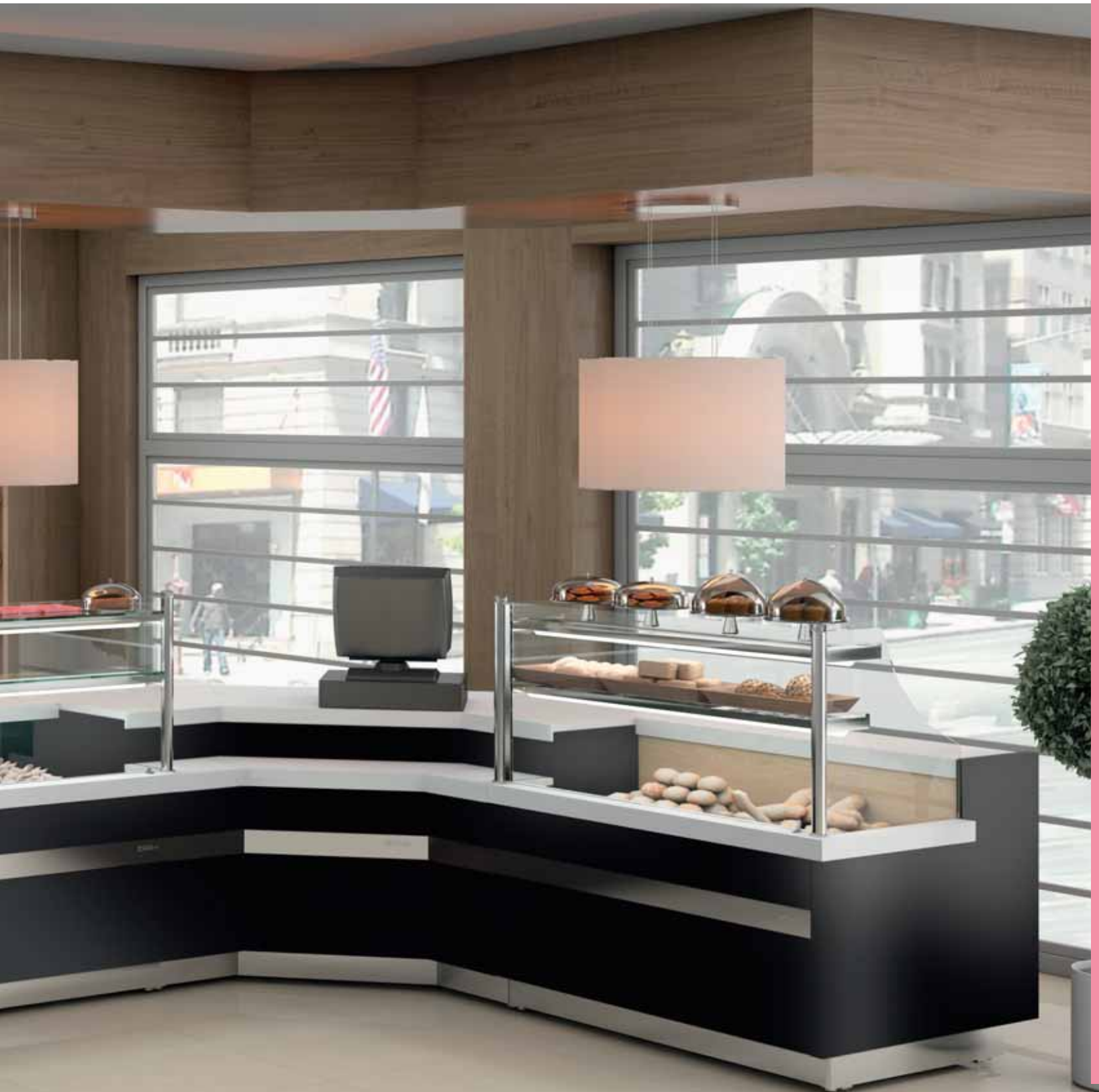

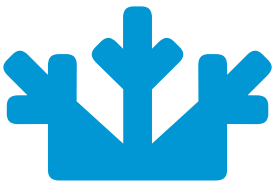

Vitrine d'exposition froid ventilé modulaire pour cafétéria et pâtisserie avec réserve

Série **MAGNUS**

Photos non contractuelles

À SOULIGNER



Contrôle

Le système de contrôle a une **plus grande précision** dans le contrôle de la **température** et de l'**humidité**. Plus **facile d'ajuster** la gamme de **température** que nous voulons atteindre.



Fuites de gaz

Toutes les Unités de condensation sont **100% testées en chambre d'hélium** pour détecter les fuites de gaz.



Éclairage

Éclairage LED, réduisant la consommation énergétique **entre 80% et 90%**. Éclairage à tous les niveaux et à l'avant pour mettre en valeur les produits.



Certificats de conformité

Infrico est certifié par l'organisme international AENOR en **ISO 9001:2015** [Qualité]; **ISO 14001:2015** [Environnement]; **OSHAS 18001:2007** [Sécurité et Santé de l'employé]. Contrôlé et Certifié par **INTERTEK** conforme aux **UL 471** et **NSF 7**.



VMG 12 R

MOD.	Portes coulissantes arrière	Prix (€)
VMG 9 R	PUEVMG9CT	147 €
VMG 12 R	PUEVMG12CT	214 €
VMG 15 R	PUEVMG15CT	284 €
VMG 18 R	PUEVMG18CT	351 €
VMG 25 R	PUEVMG25CT	435 €

En option portes coulissantes arrière

MOD.	Joues (mm)	Puissance (W)	Capacité (L)	Portes	Surface d'exposition (m ²)	Étagères	Compresseur (HP)	Consommation (kWh/24h)	Puissance frig. [W A -10°C]	Dégivrage	Contrôle	Gaz
VMG 9 R	60+60	738	103	1	0,6	2	3/8	11,8	676	Automatique	Digital	R-452
VMG 12 R	60+60	988	138	2	0,8	2	5/8	15,8	1096	Automatique	Digital	R-452
VMG 12 B	60+60	738	138	-	0,8	2	3/8	11,8	676	Automatique	Digital	R-452
VMG 15 R	60+60	1070	172	2	0,9	2	3/4	17,1	1315	Automatique	Digital	R-452
VMG 18 R	60+60	1263	206	3	1,1	2	1	20,2	1506	Automatique	Digital	R-452
VMG 25 R	60+60	1495	275	4	1,5	2	1 1/6	23,9	2009	Automatique	Digital	R-452

Vitrine d'exposition froid ventilé modulaire pour cafétéria et pâtisserie avec réserve

Série
MAGNUS

CARACTÉRISTIQUES TECHNIQUES



Structure

Plan de travail en **COMPAC quartz blanc**.
Vitres plates frontales et **latérales en sécurité**.
 Décoration en **DM hydrofuge** laqué.
 Arrière du meuble en **tôle plastifiée**.
 Décoration frontale avec **éclairage LED**.



Réfrigération

Dégivrage automatique.
 Système de **condensation ventilée**.
 Système de **d'évaporation forcé**.
 Bac d'évaporation **double gaz chaud**.

Photos non contractuelles



VMG 12 R

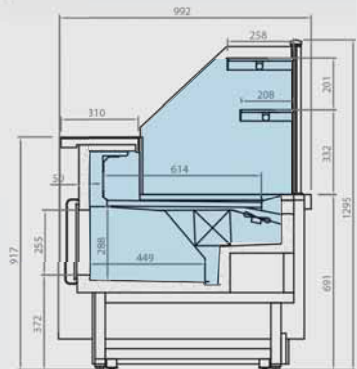

VMG 12 R



VMG 9 R
5.229 €

938 x 990 x 1345 mm.
 Temp. +4°C / +8°C
 C. Clima. 3 / 25°C
 230v/1ph/50 Hz



VMG 12 R
5.881 €

1250 x 990 x 1345 mm.
 Temp. +4°C / +8°C
 C. Clima. 3 / 25°C
 230v/1ph/50 Hz



VMG 12 B
6.313 €

1250 x 990 x 1300 mm.
 Temp. +7°C / +12°C
 C. Clima. 3 / 25°C
 230v/1ph/50 Hz



VMG 15 R
6.950 €

1562 x 990 x 1345 mm.
 Temp. +4°C / +8°C
 C. Clima. 3 / 25°C
 230v/1ph/50 Hz

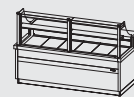

VMG 18 R
7.592 €

1875 x 990 x 1345 mm.
 Temp. +4°C / +8°C
 C. Clima. 3 / 25°C
 230v/1ph/50 Hz

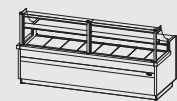

VMG 25 R
8.556 €

2500 x 990 x 1345 mm.
 Temp. +4°C / +8°C
 C. Clima. 3 / 25°C
 230v/1ph/50 Hz



Vitrine d'exposition froid ventilé modulaire pour cafétéria et pâtisserie avec réserve

Série **MAGNUS**

Photos non contractuelles

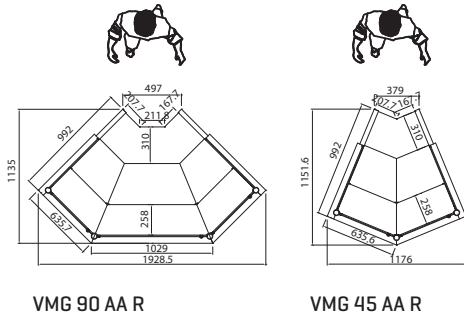

VMG 90 AA R

VMG 45 AA R

MOD.	Portes coulissantes arrière	Prix [€]
VMG45AAR	PUEVMG45AACT	122 €
VMG45ACR	PUEVMG45ACCT	193 €
VMG90AAR	PUEVMG90AACT	245 €
VMG90ACR	PUEVMG90ACCT	387 €
VMG90ARR	PUEVMG90ARCT	349 €

En option angles de portes coulissantes arrière



MOD.	Joues (mm)	Puissance (W)	Capacité (L)	Portes	Surface d'exposition (m ²)	Étagères	Compresseur (HP)	LED	Consommation (kWh/24h)	Puissance frig. (W A -10°C)	Contrôle	Gaz
VMG 90 AA R	60+60	988	-	-	0,9	2	5/8	✓	15,8	1096	Digital	R-452
VMG 90 AC R	60+60	1060	-	-	1,2	2	3/4	✓	17,0	1315	Digital	R-452
VMG 90 A R	60+60	1060	-	-	1,1	2	3/4	✓	17,0	1315	Digital	R-452
VMG 45 AA R	60+60	662	-	-	0,8	2	3/8	✓	10,6	676	Digital	R-452
VMG 45 AC R	60+60	738	-	-	0,9	2	1/2	✓	11,8	817	Digital	R-452

Vitrine d'exposition froid ventilé modulaire pour cafétéria et pâtisserie avec réserve

Série
MAGNUS

Photos non contractuelles

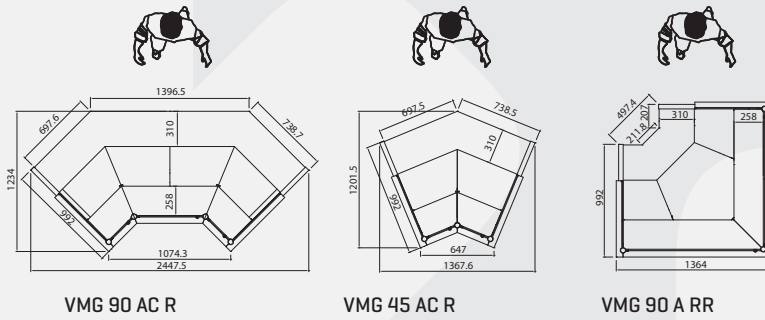

VMG 90 AA R
8.532 €

1365 x 990 x 1345 mm.
Temp. +4°C / +8°C
C. Clima. 3 / 25°C
230v/1ph/50 Hz



VMG 90 AC R
9.219 €

1750 x 990 x 1345 mm.
Temp. +4°C / +8°C
C. Clima. 3 / 25°C
230v/1ph/50 Hz



VMG 90 A RR
7.877 €

1365 x 990 x 1345 mm.
Temp. +7°C / +12°C
C. Clima. 3 / 25°C
230v/1ph/50 Hz



VMG 45 AA R
6.550 €

1180 x 990 x 1345 mm.
Temp. +4°C / +8°C
C. Clima. 3 / 25°C
230v/1ph/50 Hz



VMG 45 AC R
6.611 €

1365 x 990 x 1345 mm.
Temp. +4°C / +8°C
C. Clima. 3 / 25°C
230v/1ph/50 Hz

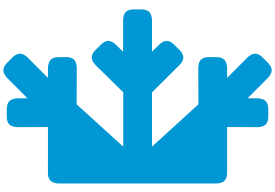

Vitrine d'exposition modulaire neutre (corbeille à pain)

Série **MAGNUS**

Photos non contractuelles

À SOULIGNER



Plan de travail en **COMPAC quartz blanc**.
Plan d'exposition **en bois**.
Vitres frontales battantes permettant un nettoyage facile.

Plan d'exposition et **étagères** avec éclairage **LED**.
Tiroir **ramasse-miettes**.



VMG 12 P



VMG 9 P
3.983 €

938 x 990 x 1345 mm.



VMG 12 P
4.357 €

1250 x 990 x 1345 mm.

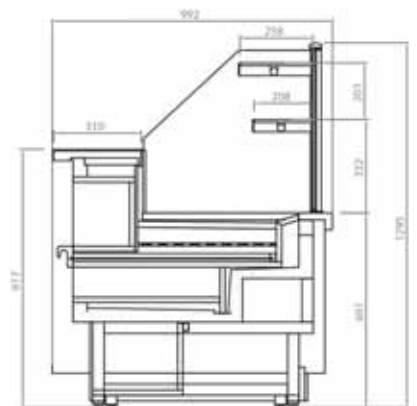

VMG P

MOD.



Joues
(mm)



Puissance
(W)



Surface
d'exposition
(m²)



Étagères



Consommation
(kWh/24h)

	Joues (mm)	Puissance (W)	Surface d'exposition (m ²)	Étagères	Consommation (kWh/24h)
VMG 9 P	60+60	24	0,6	2	0,4
VMG 12 P	60+60	30	0,8	2	0,5

Meuble caisse

Série
MAGNUS

Photos non contractuelles

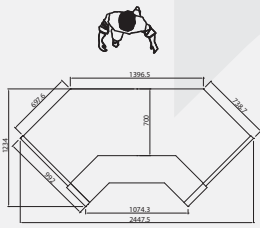

VMG 90 ACM

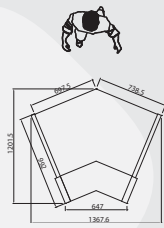

VMG 45 ACM

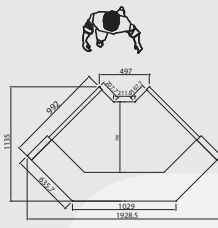

VMG 90 AAM

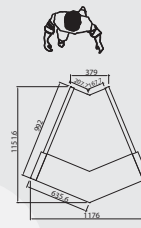

VMG 45 AAM



VMG 90 AA M



VMG 90 AA M
4.055 €

1365 x 990 x 1345 mm.

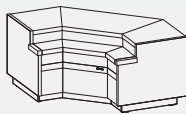

VMG 90 AC M
4.914 €

1750 x 990 x 1345 mm.



VMG 45 AA M
3.190 €

1180 x 990 x 920 mm.

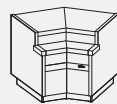

VMG 45 AC M
4.277 €

1365 x 990 x 920 mm.

MOD.



Joues
(mm)



Puissance
(W)



Tension électrique
(V/Hz)



LED



Consommation
(kWh/24h)

MOD.	Joues (mm)	Puissance (W)	Tension électrique (V/Hz)	LED	Consommation (kWh/24h)
VMG 90 AA M	60+60	7	230/50	✓	0,1
VMG 90 AC M	60+60	10	230/50	✓	0,2
VMG 45 AA M	60+60	5	230/50	✓	0,1
VMG 45 AC M	60+60	7	230/50	✓	0,1



Meuble caisse

Série
MAGNUS

Photos non contractuelles

À SOULIGNER



Plan de travail et repose sacs en **COMPAC quartz blanc**.
Décoration en **DM** laqué.

Bande avec éclairage **LED** sur la décoration frontale.
Étagères arrière en **bois stratifié** blanc.



VMG 12 M

Noyer

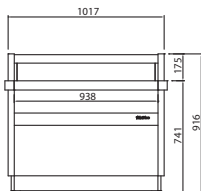

VMG 9 C

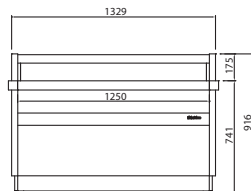

VMG 12 M

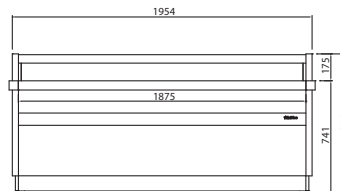

VMG 18 M

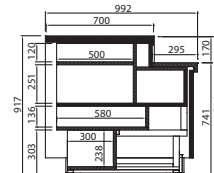

VMG 9 C
2.278 €

938 x 810 x 1300 mm.

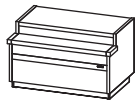

VMG 12 M
2.888 €

1250 x 810 x 1300 mm.



VMG 18 M
3.887 €

1250 x 810 x 1300 mm.



VMG 12 MHD
3.312 €

1250 x 810 x 1300 mm.

MOD.



Joues
(mm)



Puissance
(W)



Tension
électrique
(V/Hz)



Consommation
(kWh/24h)

MOD.	Joues (mm)	Puissance (W)	Tension électrique (V/Hz)	Consommation (kWh/24h)
VMG 9 C	60+60	5	230/50	0,1
VMG 12 M	60+60	7	230/50	0,1
VMG 18 M	60+60	10	230/50	0,2
VMG 12MHD	60+60	7	230/50	0,1















Décorations

Série
MAGNUS

Photos non contractuelles



Décoration standard

	RAL 4007 Violet		RAL 3003 Grenat		RAL 3020 Rouge		Noyer
	RAL 2003 Orange		RAL 1018 Jaune		RAL 1001 Beige		Wenge
	RAL 5015 Bleu		RAL 9016 Blanc		RAL 6002 Vert foncé		RAL 9017 Noir
	RAL DESIGN 3504035 Rose		RAL DESIGN 2108025 Bleu ciel		RAL DESIGN 1107060 Pistache		

Couleurs spéciales, hors liste

Couleur	Type	Supplément délai de livraison	Supplément PVP [x demandé]
RAL	Epoxi	+10 Jours de travaux	675,00 €
	Liquide	+10 Jours de travaux	420,00 €
NO RAL	Epoxi	Consulter	Consulter
	Liquide	Consulter	Consulter