

MODELS: **VMD90AA R/S** **VMD90AC R/S**
VMD45AA R/S **VMD45AC R/S**

Refrigerated modular display case – Curved with/without storage Madrid series.

Strengths

- ✓ **Combination of different cooling system modules: ventilated, half-static and static. Modules with or without cooled storage. Angles and counters to adapt the line to a space.**
- ✓ **Greater precision in temperature control. Easier to adjust the temperature range we want to achieve.**
- ✓ **All condenser units are tested 100%, in helium chambers to refrigerant leak detections.**
- ✓ **LED lighting incorporated, reducing energetic consumption between 80% and 90% respect to a traditional light bulb.**
- ✓ **Infrico is AENOR audited and certified by internationally recognized firm. ISO 9001:2015 (Quality); ISO 14001:2015 (Environmental); OSHAS 18001:2007 (Prevention and Worker Safety). Audited and Certified by INTERTEK for compliance with UL 471 and NSF 7.**

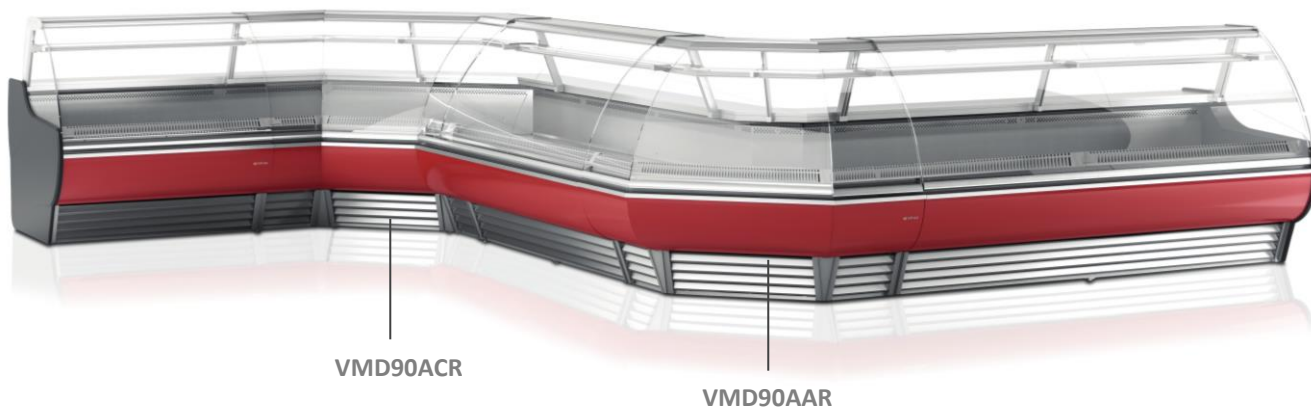

MODELS	Dimensions (mm)			Sides thickness (mm)	Nº of shelves	Exposure surface (m ²)	Gross volume (L)	Temp. regime (°C)	Ref.	Net weight (Kg.)
	Length	Depth	Height							
VMD90AA R/S	1326	1150	1290	30 + 30	1	1,15	1967	0°C/+6°C	R452	225
VMD45AA R/S	1108	1150	1290	30 + 30	1	0,63	1644	0°C/+6°C	R452	154
VMD90AC R/S	1887	1150	1290	30 + 30	1	1,49	2800	0°C/+6°C	R452	201
VMD45AC R/S	1470	1150	1290	30 + 30	1	0,75	2180	0°C/+6°C	R452	179

MODELS: **VMD90AA R/S** **VMD90AC R/S**
VMD45AA R/S **VMD45AC R/S**

Refrigerated modular display case – Curved with/without storage Madrid series.

STANDARD FEATURES

➤ Modular line

- Different cooling system modules can be combined using complete dividers.
- Designed for meat and precooked and packaged foods, charcuterie, milk products and sandwiches.

➤ Exterior

- Plastic coated steel exterior.
- AISI 304 stainless steel worktop.
- AISI 304 stainless steel exposure surface.
- Lacquered DM decoration.
- Folding secured curved glass.

➤ Interior

- Plastic coated steel interior.
- Enamelled steel base.
- LED lighted middle shelf and exposure surface.
- Storage door clearance of 425x255 mm.

➤ Insulation

- Insulation by free CFC's polyurethane, foam high-pressure injected with density 40 Kg/m³.
- Zero ODP and Low GWP.

➤ Refrigeration

- Temperature and defrost regulated by a digital controller.
- Automatic defrost.
- Ventilated condensation system.
- Forced evaporation system.
- Stainless steel evaporative tray with double vat, one for hot gas and another with electrical heater.
- Climatic class 4 (30°C, 55%RH).

➤ Electrical

- Electrical connection: 230 V / 1 ph / 50 Hz.



OPTIONAL

- Sliding back doors.
- Range of decoration colours (consult).
- Electrical connection 230 V / 1 ph / 60 Hz.
- Electrical connection 115 V / 1 ph / 60 Hz.

MODEL	Dimensions palletizing (mm)			Pallet weight (Kg.)	Power (W)	Comp. (HP)	Cooling power (W at -10°C)	Consumption (kWh/24h)	Inten. (A)	Container 20' / 40' / 40' HC	Trailer
	Length	Depth	Height								
VMD90AA R/S	2660	1200	1500	338	990	5/8	1096	13,9	5,3	2 / 4 / 4	10
VMD45AA R/S	1200	1200	1500	200	670	3/8	676	9,4	3,5	4 / 9 / 9	22
VMD90AC R/S	1955	1200	1500	234	1060	3/4	1315	14,8	5,1	4 / 9 / 9	13
VMD45AC R/S	1570	1200	1500	201	740	1/2	817	10,4	3,8	4 / 9 / 9	16

MODELS:	VMD90AA R/S VMD45AA R/S	VMD90AC R/S VMD45AC R/S	<i>Refrigerated modular display case – Curved with/without storage Madrid series.</i>
---------	--	--	---

GENERAL VIEW

FRONT VIEW

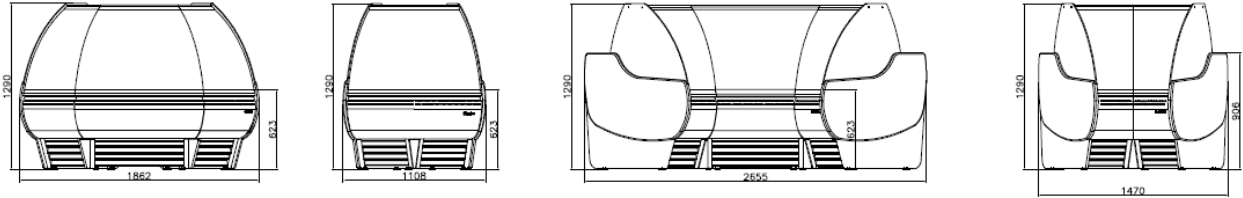

TOP VIEW

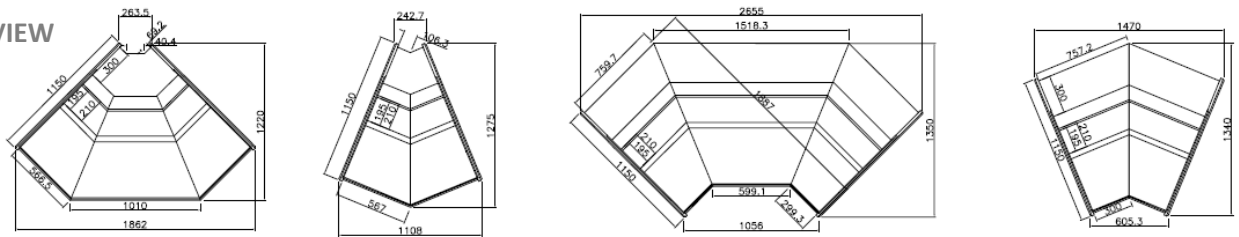

VMD90AA R/S

VMD45AA R/S

VMD90AC R/S

VMD45AC R/S

SIDE VIEW

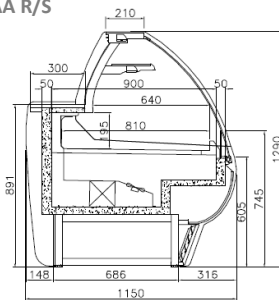

CONNECTIONS

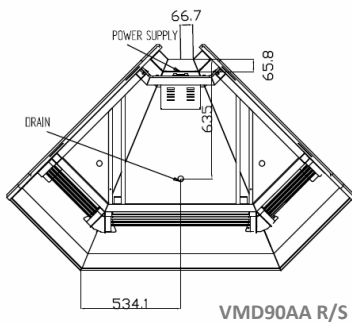

VMD90AA R/S

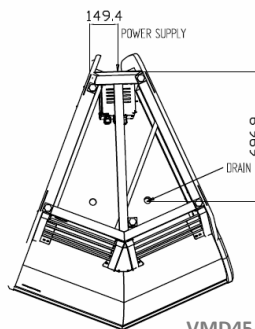

VMD45AA R/S

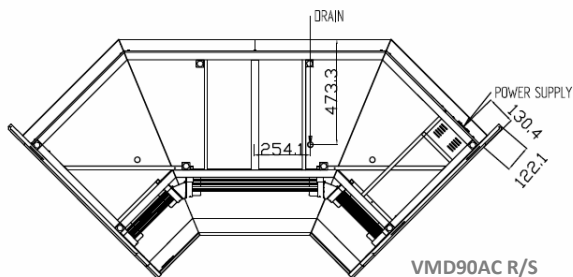

VMD90AC R/S

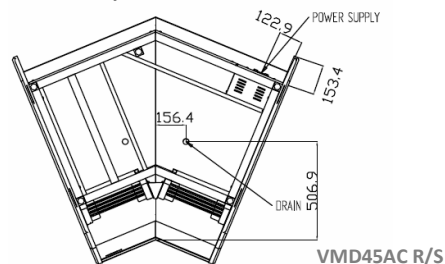

VMD45AC R/S