

# ME30/1000-ME30/1500-ME30/2000-ME30/2500



ME30/2000

[www.infrico.com](http://www.infrico.com)  
[info@infrico.com](mailto:info@infrico.com)

Ctra. de Aguilar A-318 por Moriles Km. 15,5 – A-3132 - 14900, Lucena (Córdoba)

Características técnicas y constructivas sujetas a variación sin previo aviso  
We reserve the right to change specifications without prior notice  
Les caractéristiques techniques et la conception peuvent être sujettes à modifications, sans préavis



Rev: 01  
Fecha/Date: 16/09/2019 FT\_ME30/1000\_00\_ES\_EN\_FR\_19\_01  
FT\_ME30/1500\_00\_ES\_EN\_FR\_19\_01  
FT\_ME30/2000\_00\_ES\_EN\_FR\_19\_01  
FT\_ME30/2500\_00\_ES\_EN\_FR\_19\_01

# ME30/1000-ME30/1500-ME30/2000-ME30/2500

ALZADO/ ELEVATION/ VUE LATÉRAL

PLANTA/PLAN VIEW/DESSUS/VUE DE PROFIL

PERFIL / RIGHT VIEW / VUE EN PLAN

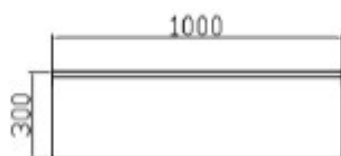
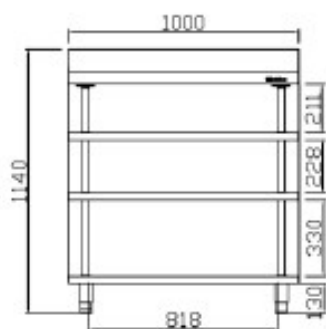

ME30/1000

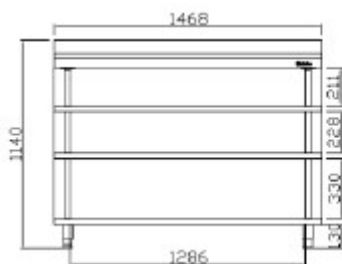
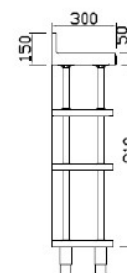

ME30/1500

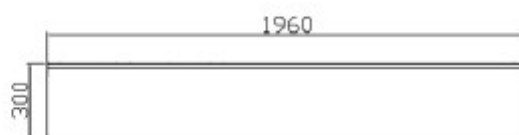
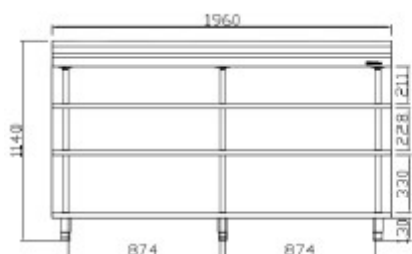
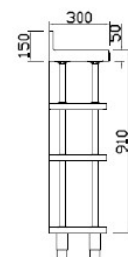

ME30/2000

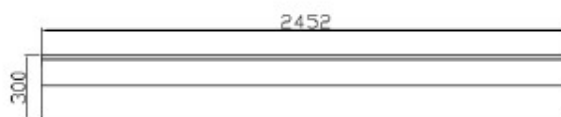
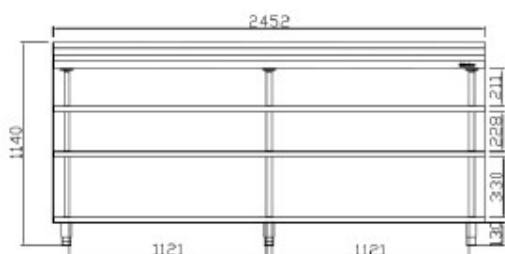
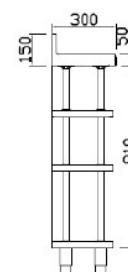

ME30/2500

